

REFRIGERATOR MANUFACTURER
Turbo air

Headquarter: 1250 Victoria street
CARSON, CA 90746
& Canada Toll Free 800-627-0032
TEL: 310-900-1000
FAX: 310-900-1077
www.turboairinc.com
0210001

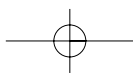

REFRIGERATOR MANUFACTURER
Turbo air

Commercial Refrigerator & Freezer Service Manual

Model No.: TGM-69R
TGM-48R
TGM-45R
TGM-35R
TGM-33R
TGM-22R
TGM-22RV
TGM-14R
TGM-14RV
TGM-11R
TGM-11RV
TGM-5R
TGF-49F
TGF-23F
TGF-13F
TGF-9F

Turbo air REFRIGERATOR MANUFACTURER

Commercial Refrigerator Service Manual

Model No.: TGM-69R
TGM-48R
TGM-45R
TGM-35R
TGM-33R
TGM-22R
TGM-22RV
TGM-14R
TGM-14RV
TGM-11R
TGM-11RV
TGM-5R
TGF-49F
TGF-23F
TGF-13F
TGF-9F

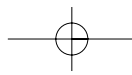

TABLE OF CONTENTS

<REFRIGERATOR>

1. FEATURE CHART	2
2. WIRING DIAGRAM	12
3. REFRIGERANT CYCLE DIAGRAM	17
4. SPECIFICATION OF MAIN COMPONENTS	18
5. TROUBLE SHOOTING CHART	21
1. REFRIGERATION SYSTEM	21
2. REFRIGERATION SYSTEM	22
3. LIGHTING SYSTEM	23
4. NOISE LEVEL	24
6. PARTS DIAGRAM	25
1. CASTER PARTS	25
2. COMPRESSOR PARTS	26
3. DOOR PARTS	30
4. EVAPORATOR PARTS	34
5. LIGHTING PARTS	40
6. SHELF PARTS	45
7. ADVERTISING & ADVERTISING FRAME PARTS	46
8. GRILL PARTS	48
9. HOW TO REPLACE THE THERMOSTAT.....	49
7. PARTS LIST	50
8. REPLACEMENT OF MAIN COMPONENTS	58
1. LAMP	58
2. THERMOSTAT AND LIGHT SWITCH	67
3. COOLING FAN MOTOR & BLADE	74
4. CONDENSER FAN MOTOR & BLADE	83
5. DOOR	87

<FREEZER>

1. FEATURE CHART	89
2. PARTS DETAILS	93
3. WIRING DIAGRAM	95
4. SPECIFICATION OF MAIN COMPONENTS	97
5. ELECTRONIC CONTROLLER INSTRUCTION	99
6. PARTS LIST	105
7. REPLACEMENT OF MAIN COMPONENTS	109

<TGF-23F>

7-1. BOTTOM GRILLE PARTS	109
7-2. REPLACING DOOR	113

<TGF-49F>

7-1. TOP ADVERTISING PANEL.....	116
7-2. BOTTOM GRILL PARTS.....	119
7-3. REPLACING DOOR	122
7-4. REPLACING INNER CABINET LAMP	124

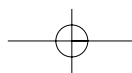

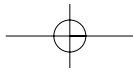

1. FEATURE CHART

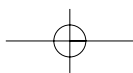
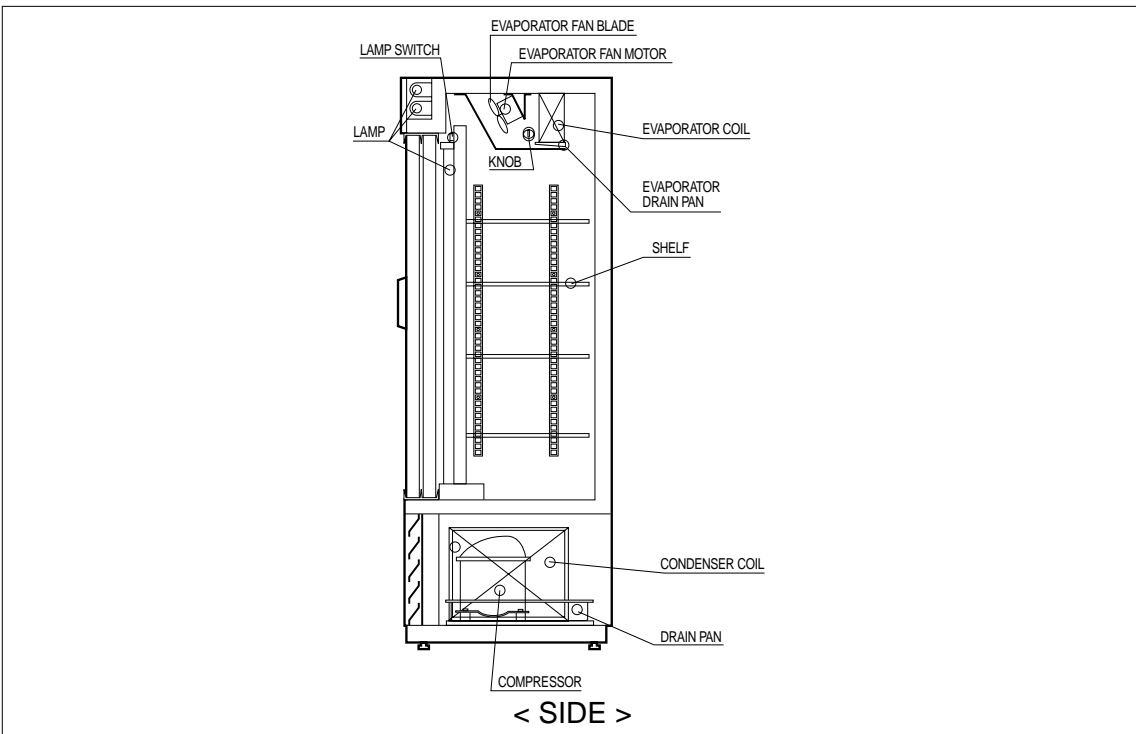
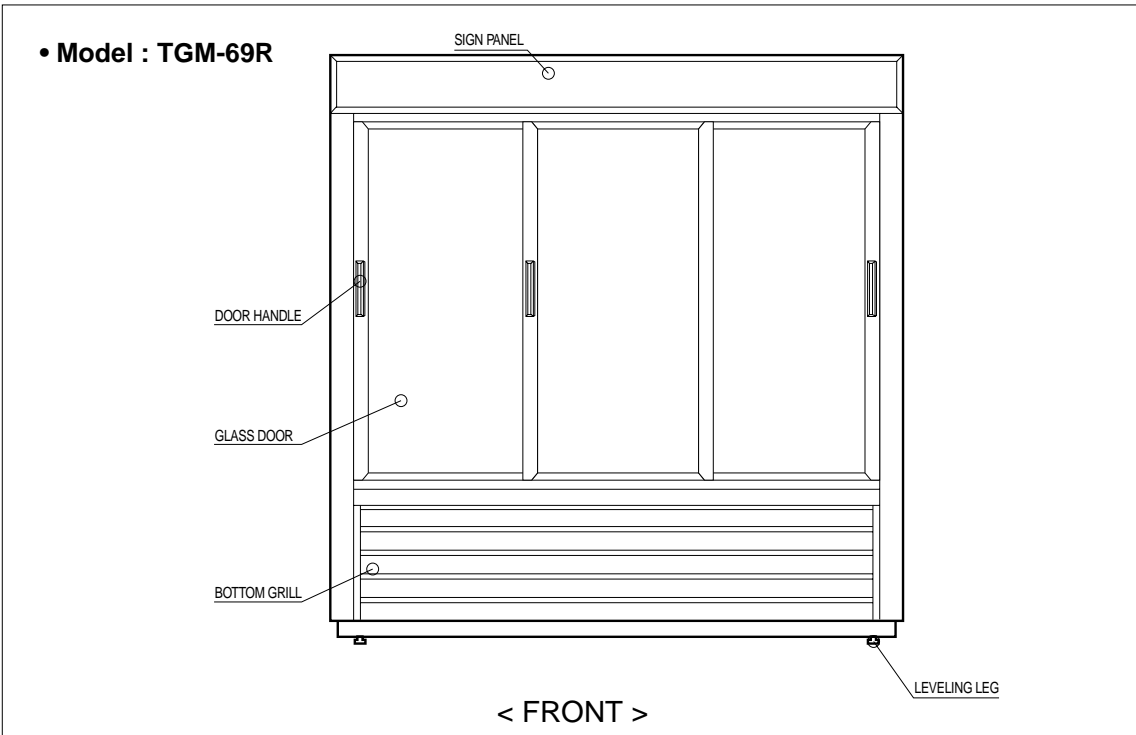

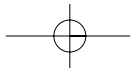

FEATURE CHART

• Model : TGM-48R, 45R, 35R, 33R

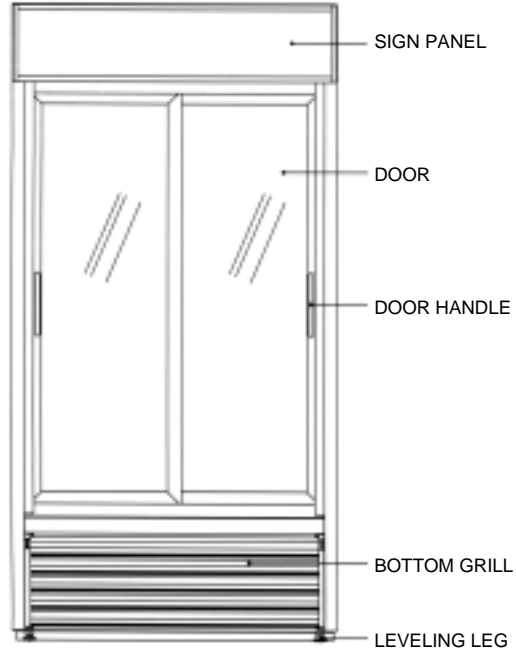

< FRONT >

• Model : TGM-48R, 35R

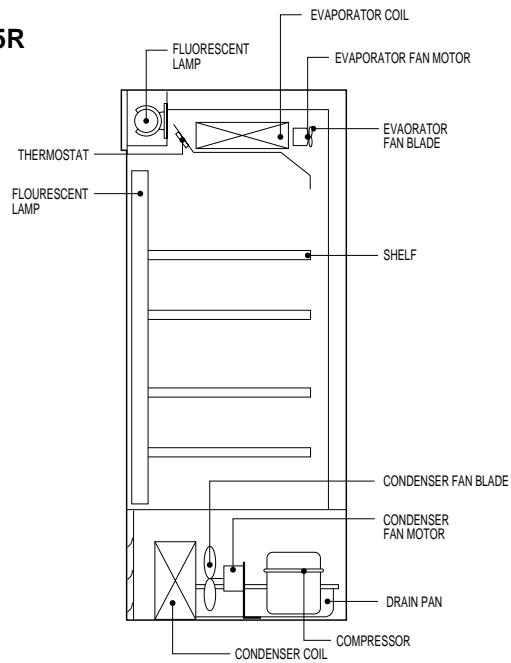

< SIDE >

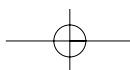

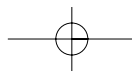

FEATURE CHART

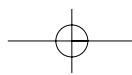
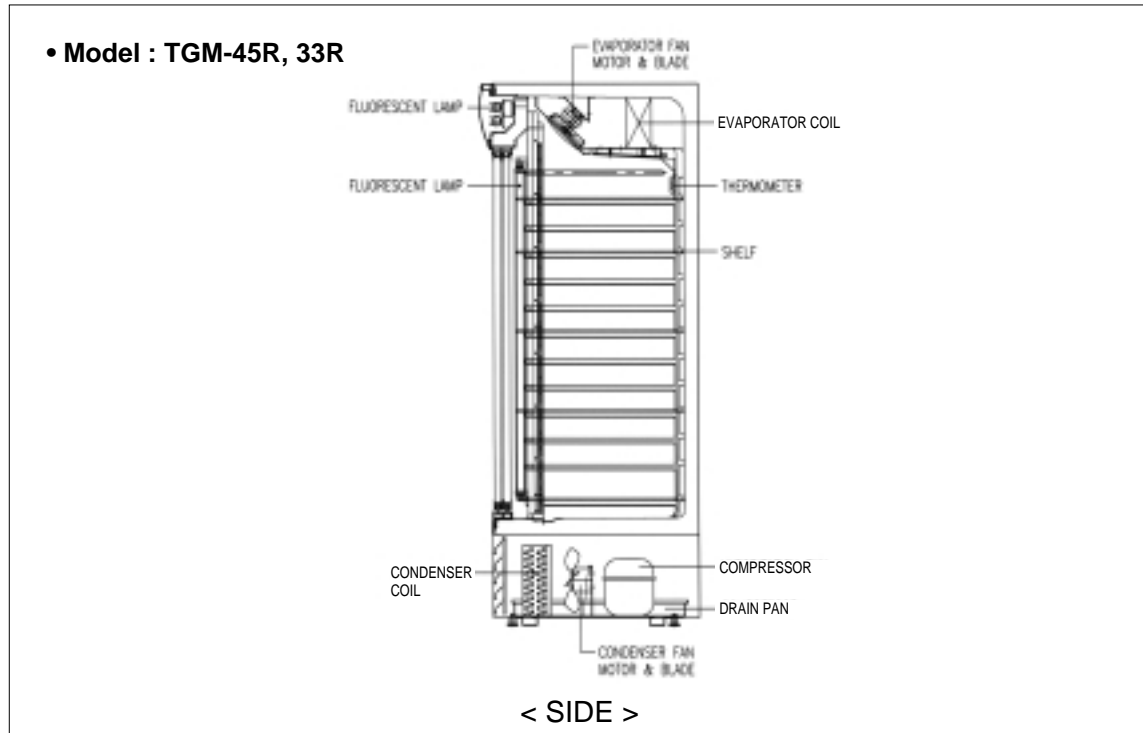

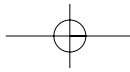

FEATURE CHART

• Model : TGM-22R

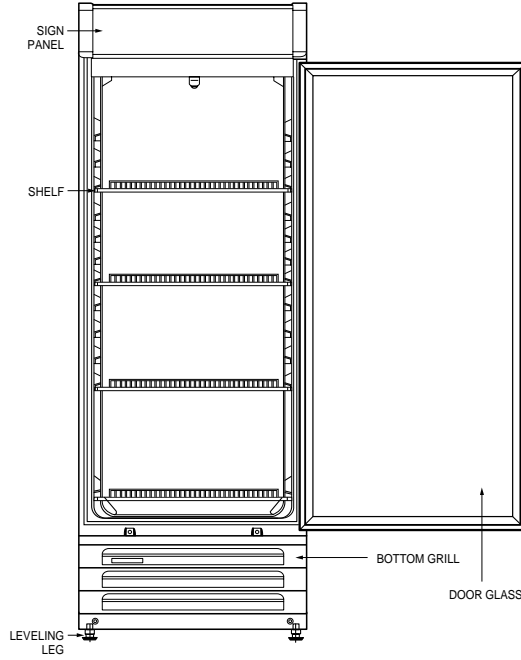

< FRONT >

• Model : TGM-22R

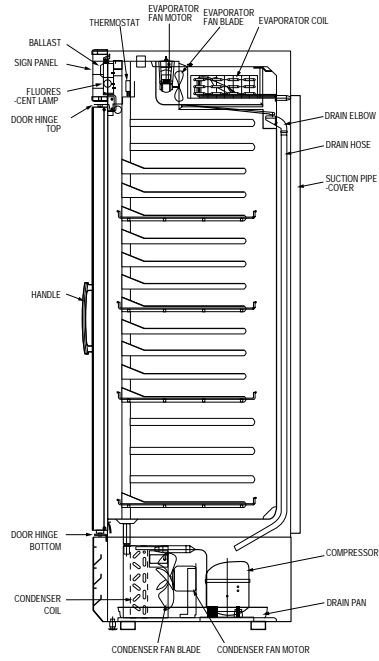

< SIDE >

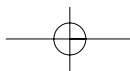

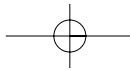

FEATURE CHART

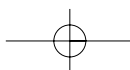
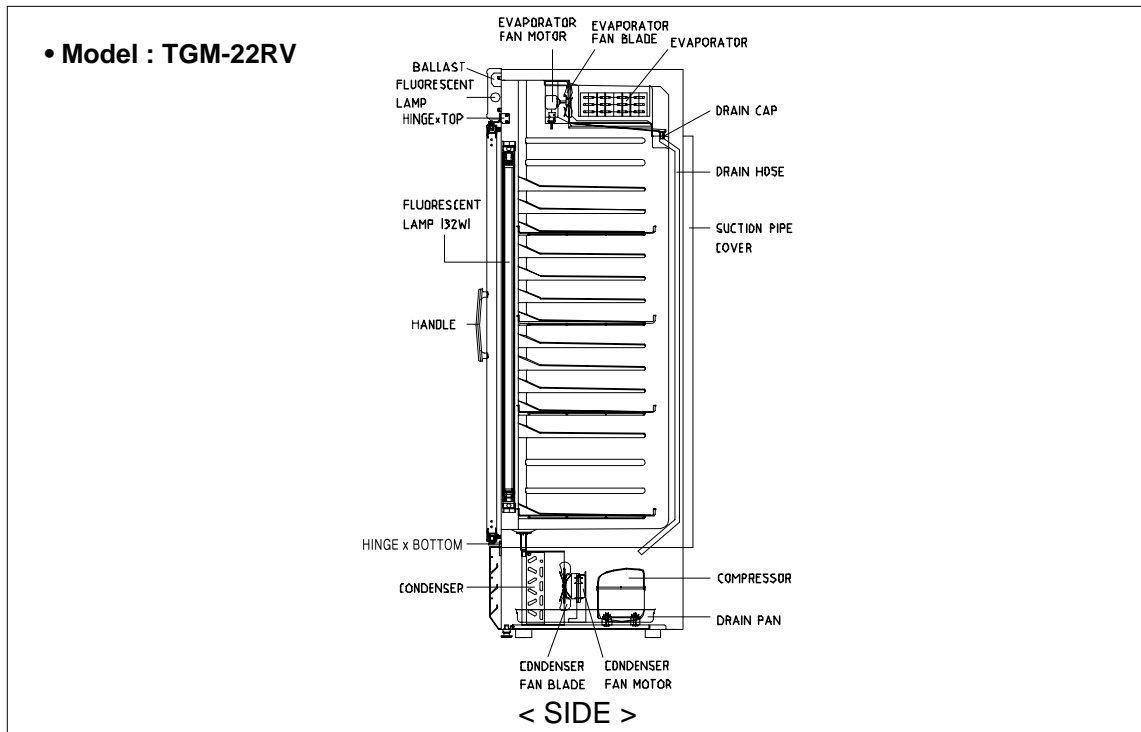
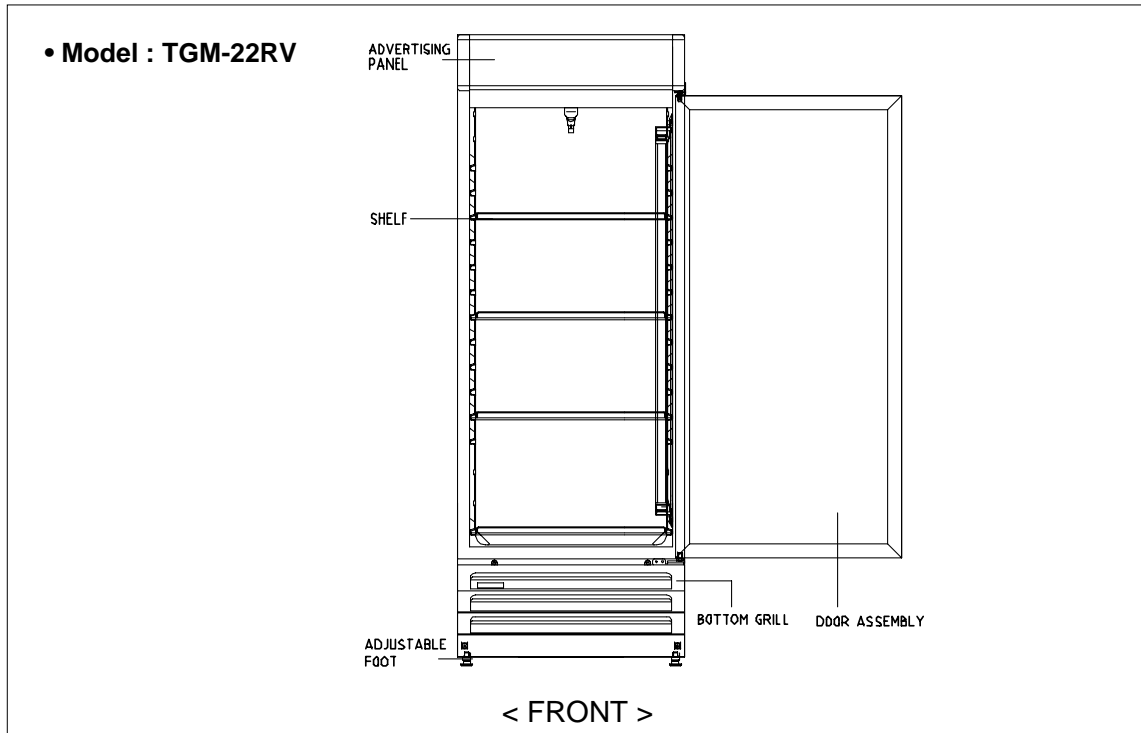

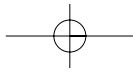

FEATURE CHART

• Model : TGM-14R

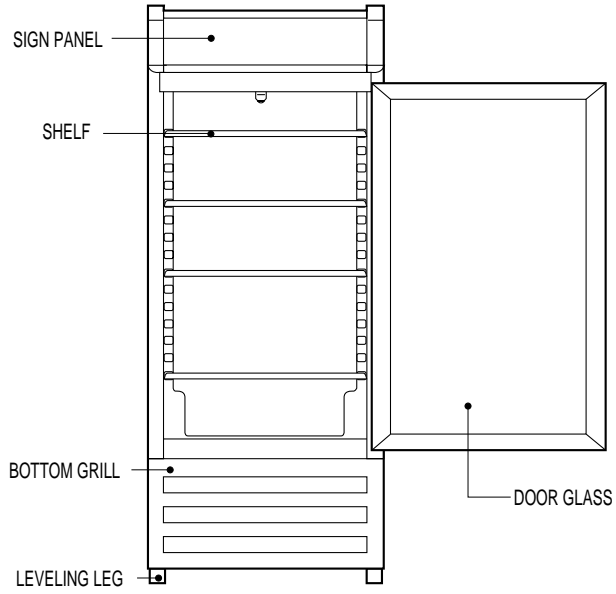

< FRONT >

• Model : TGM-14R

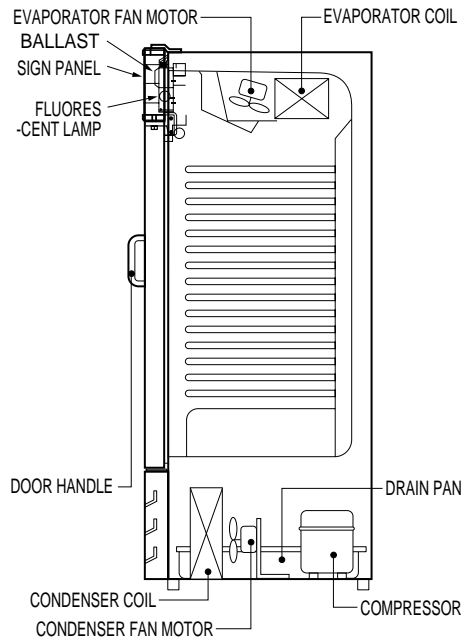

< SIDE >

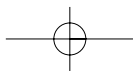

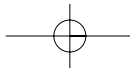

FEATURE CHART

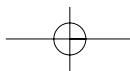
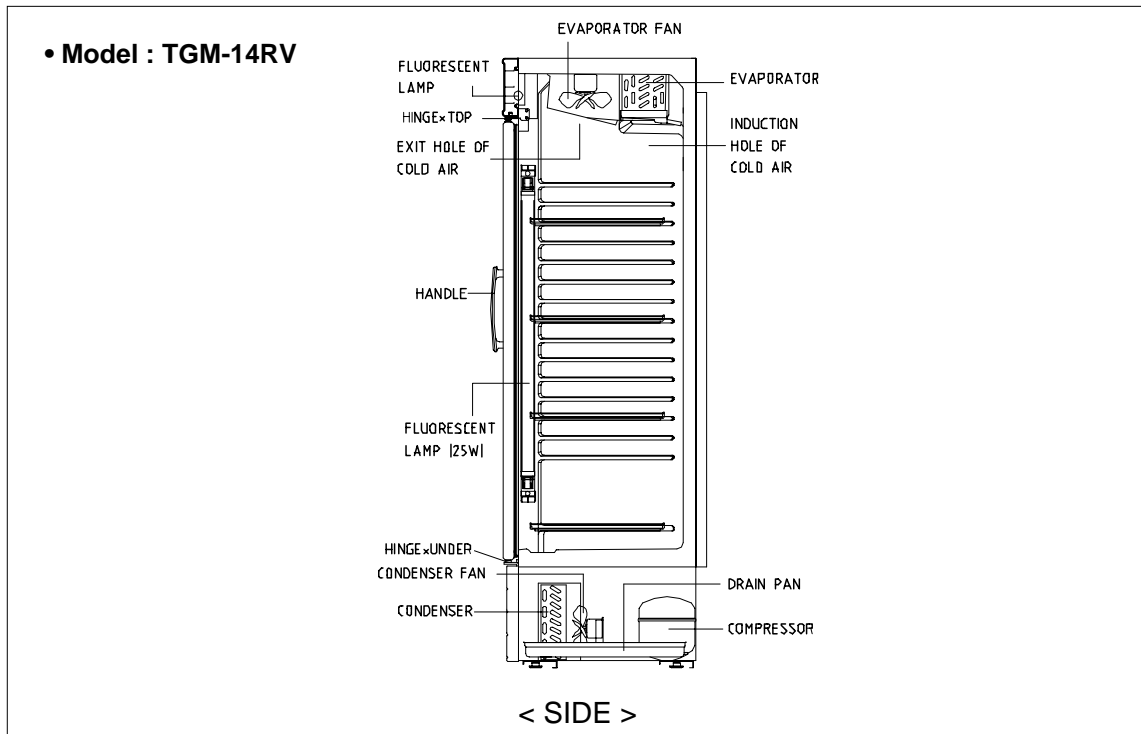
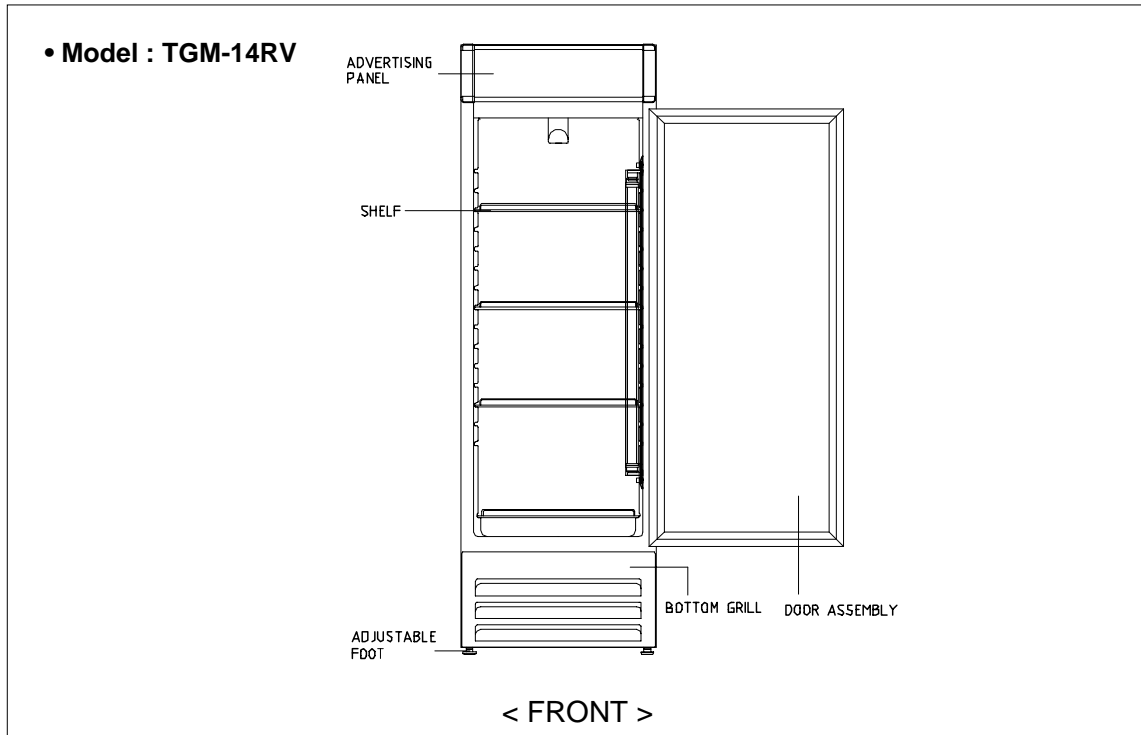

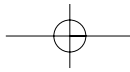

FEATURE CHART

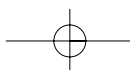
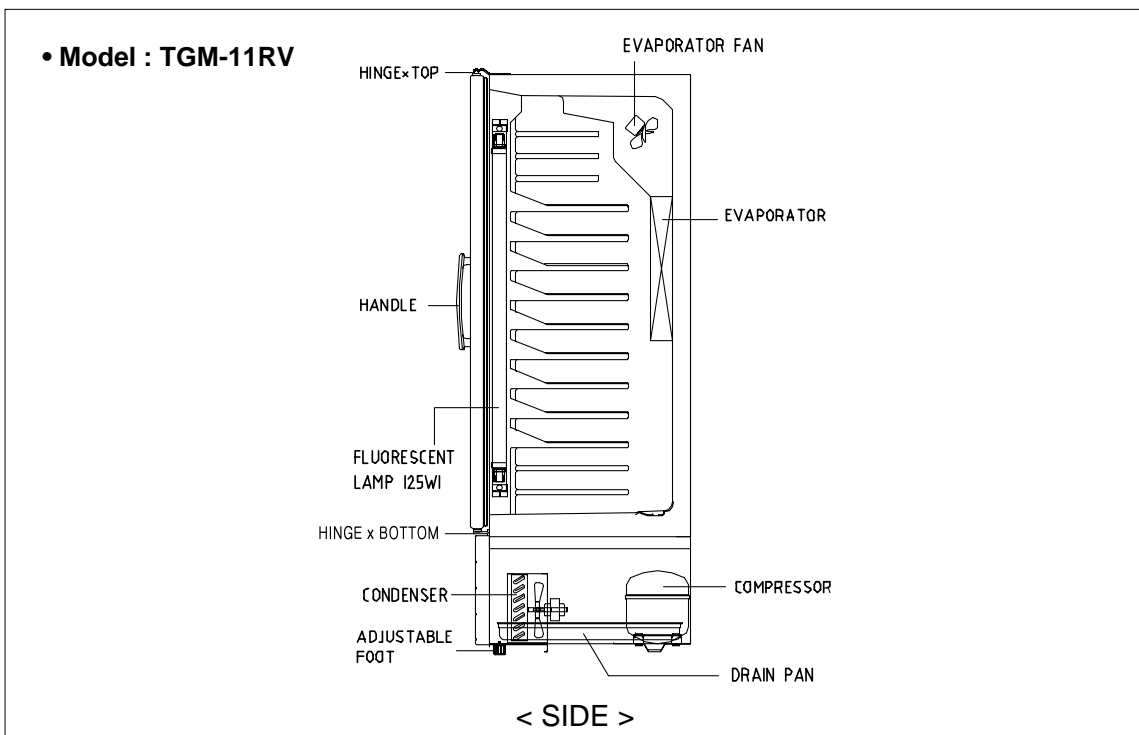
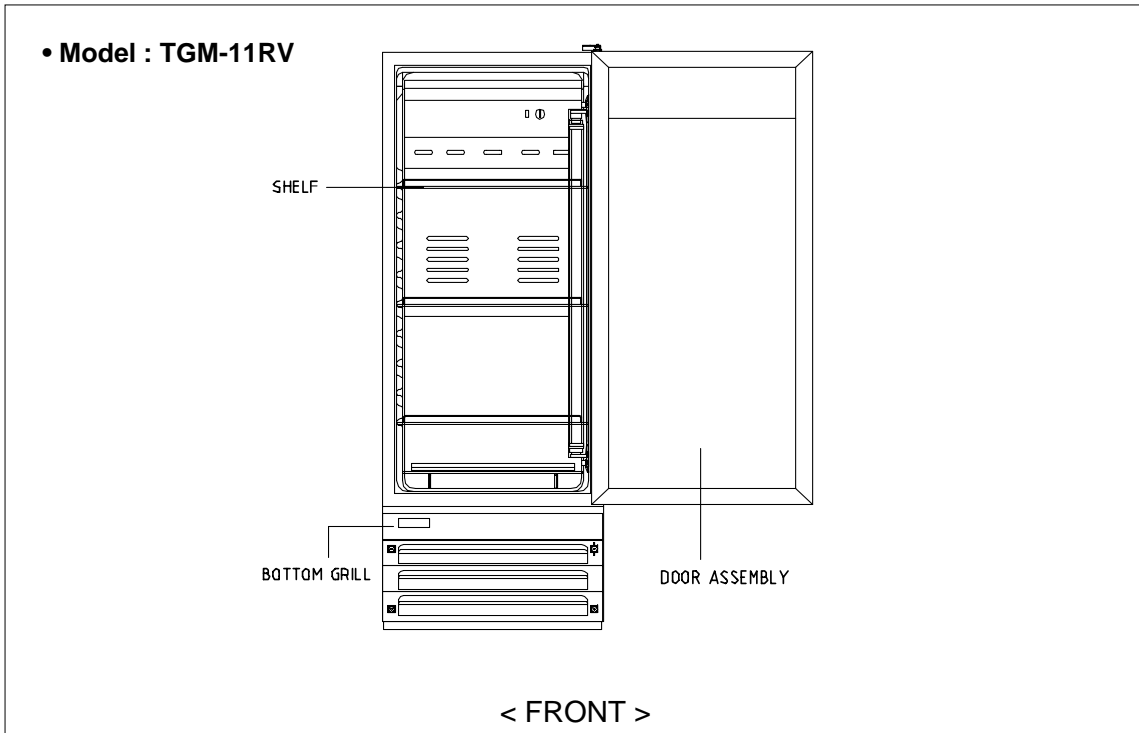

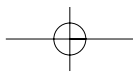

FEATURE CHART

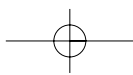
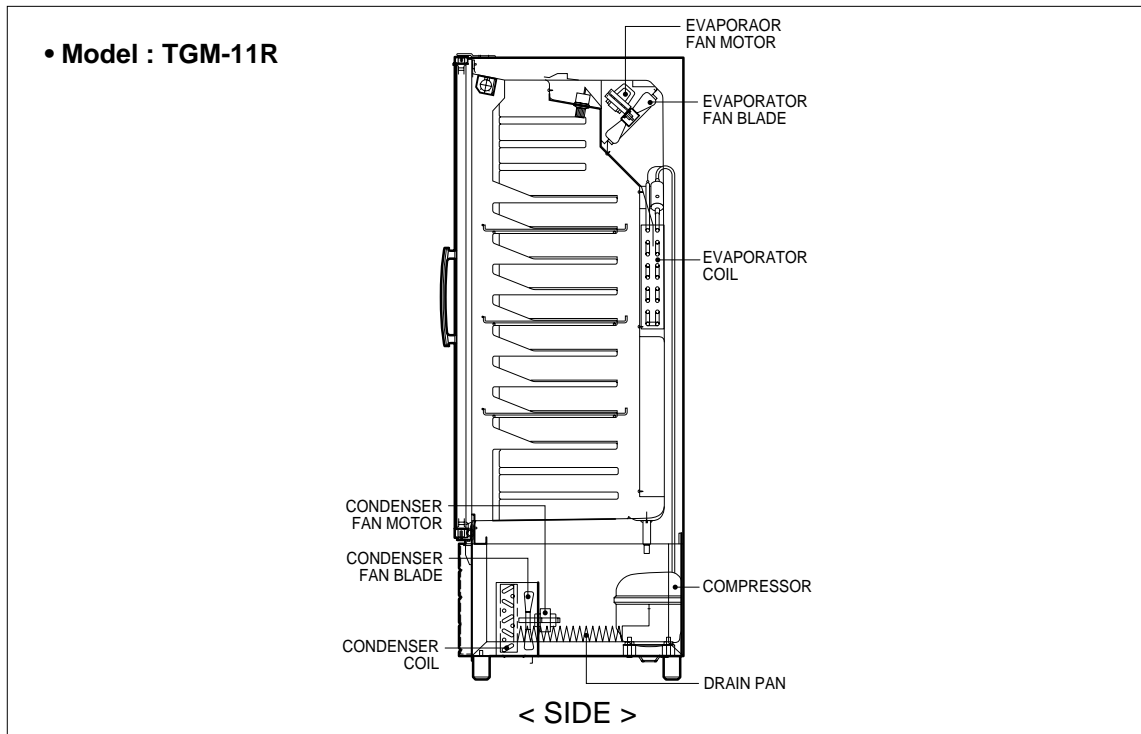
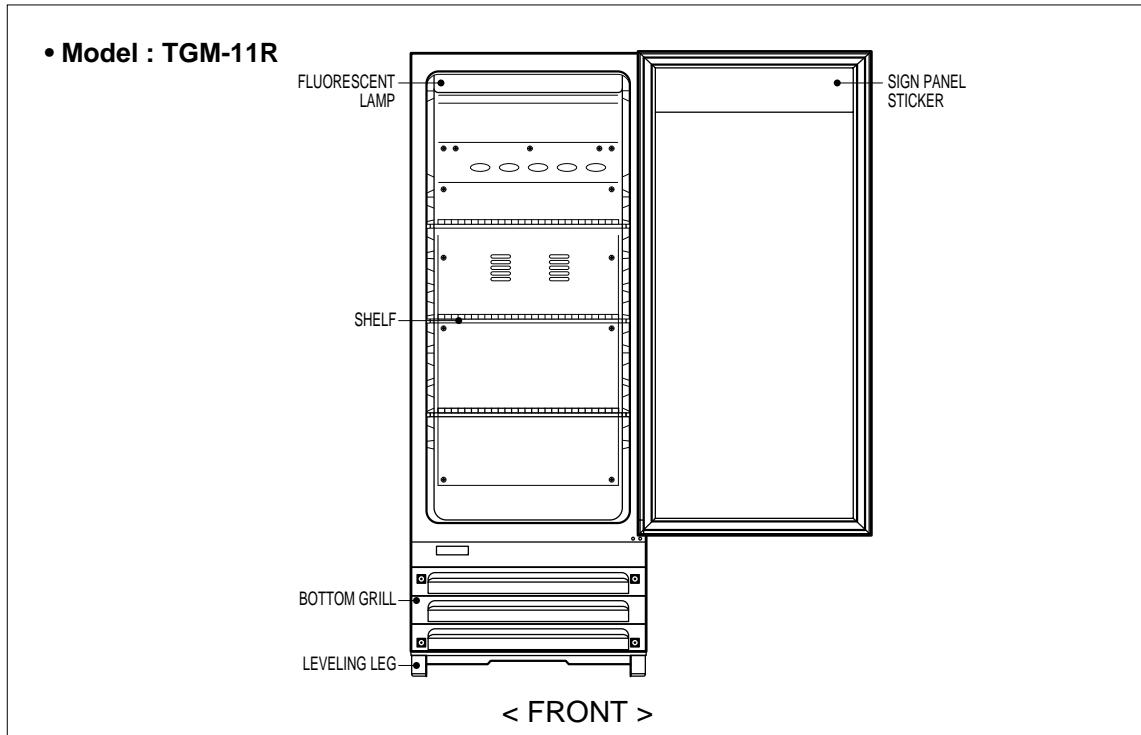

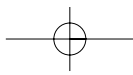

FEATURE CHART

• Model : TGM-5R

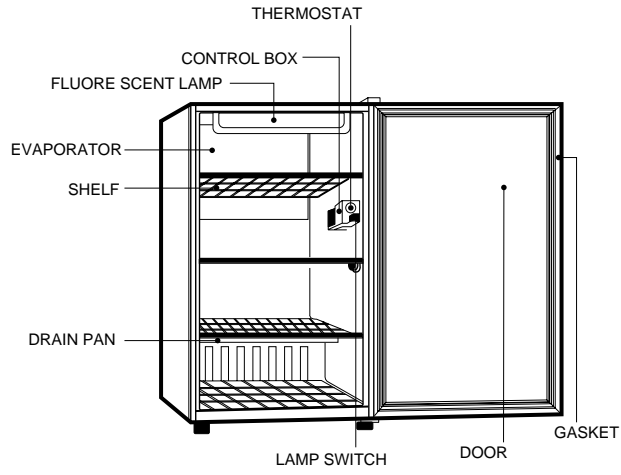

< FRONT >

• Model : TGM-5R

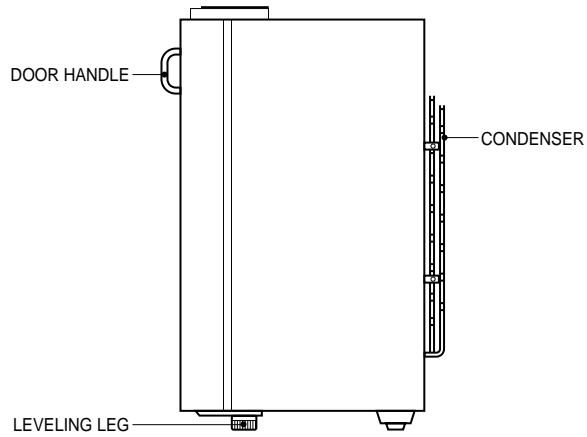

< SIDE >

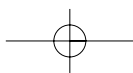

2. WIRING DIAGRAM

• Model : TGM-69R

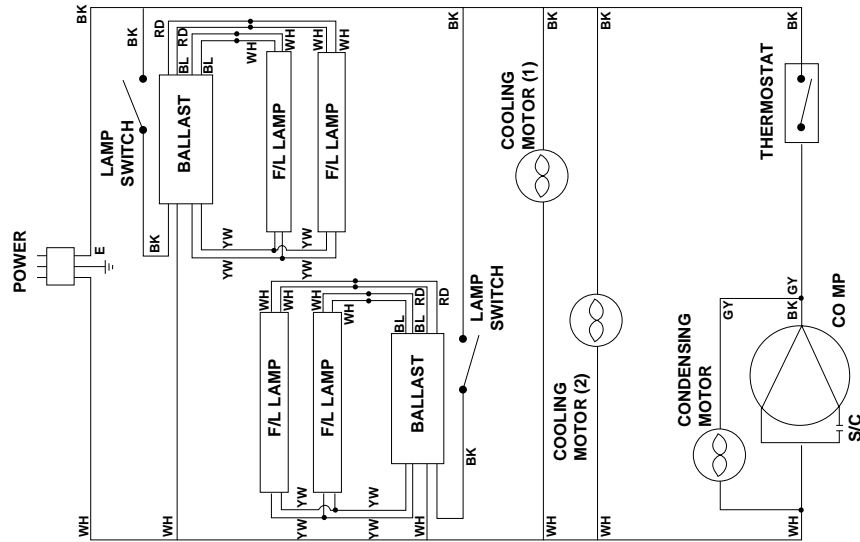

• Model : TGM-48R

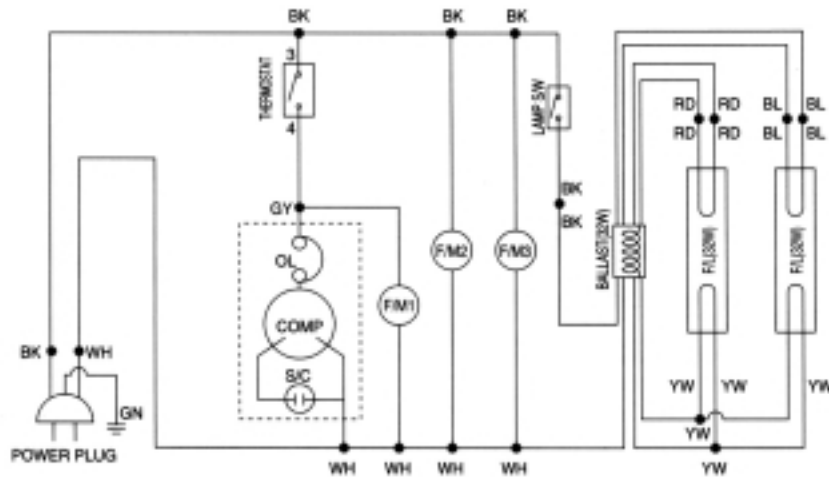

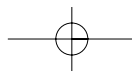

WIRING DIAGRAM

• Model : TGM-45R

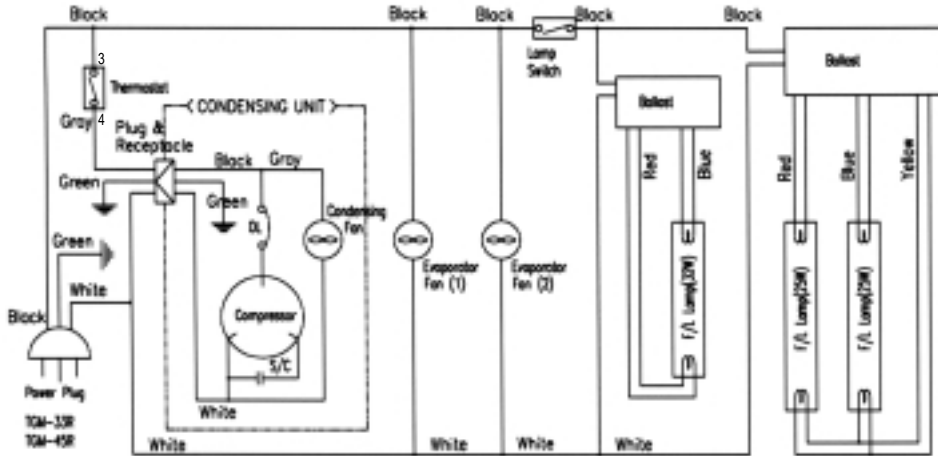

• Model : TGM-35R

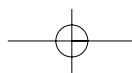
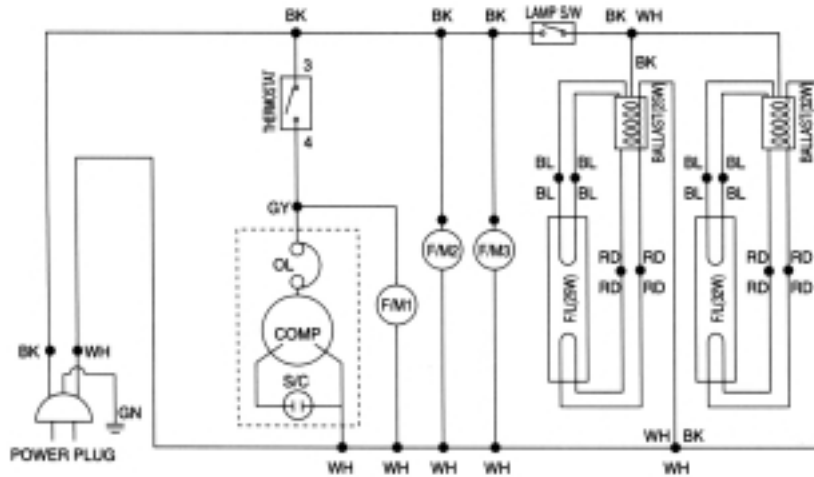

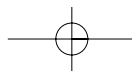

WIRING DIAGRAM

• Model : TGM-33R

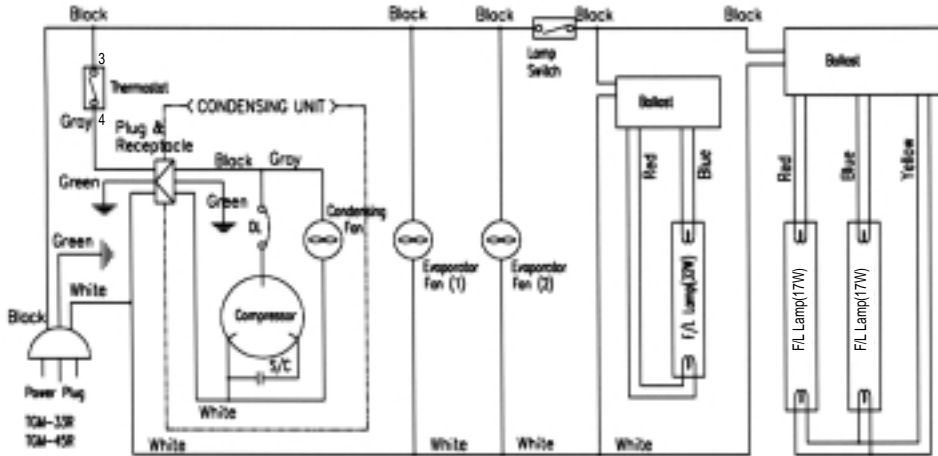

• Model : TGM-5R

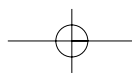
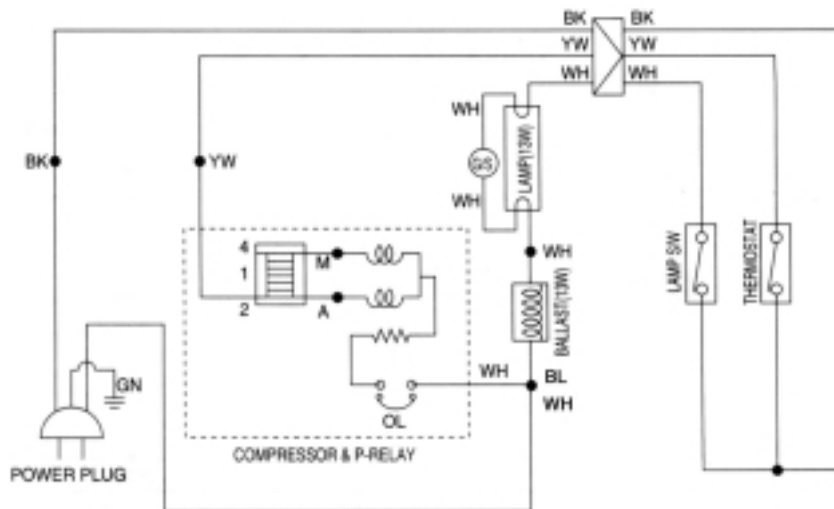

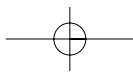

WIRING DIAGRAM

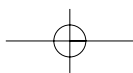
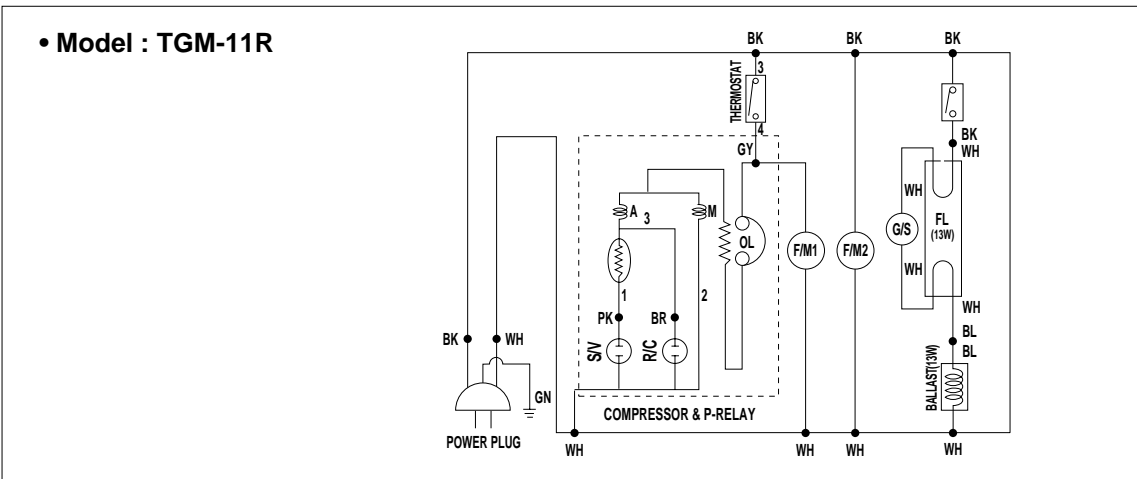
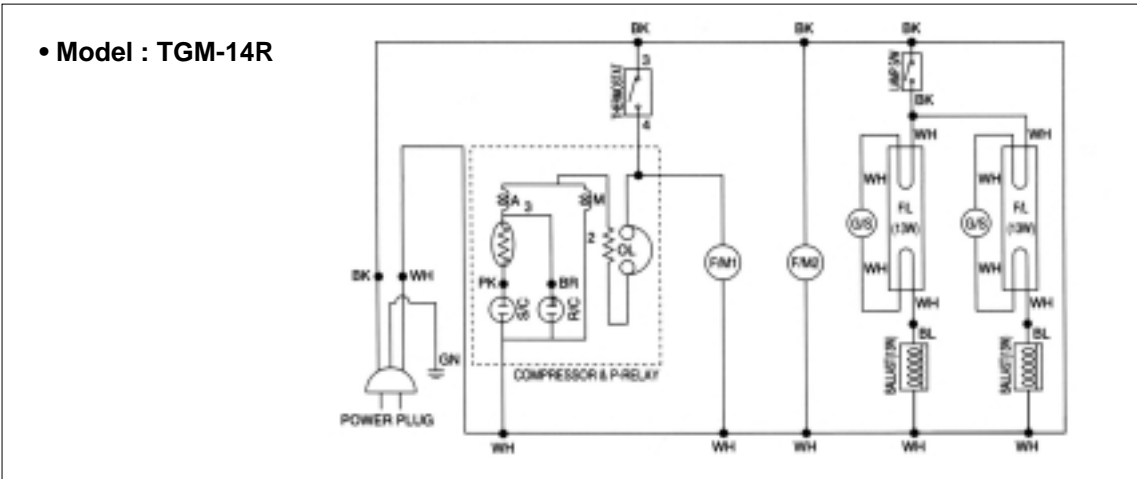
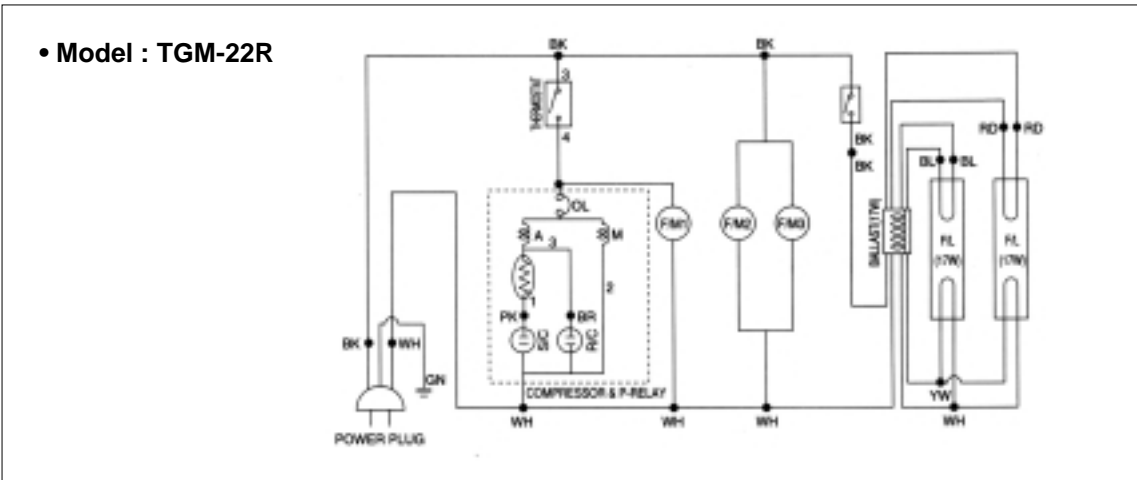

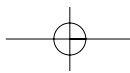

WIRING DIAGRAM

• Model : TGM-22RV

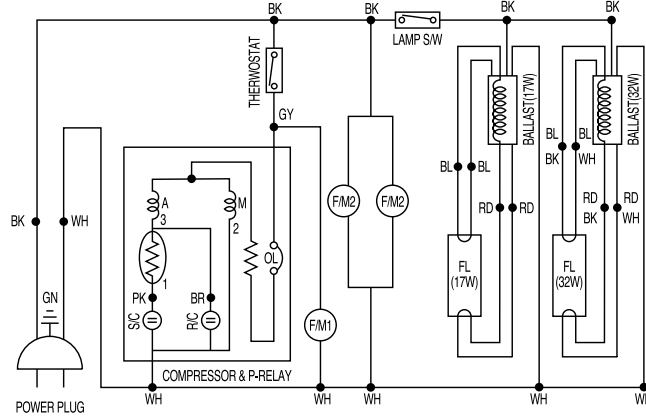

• Model : TGM-14RV

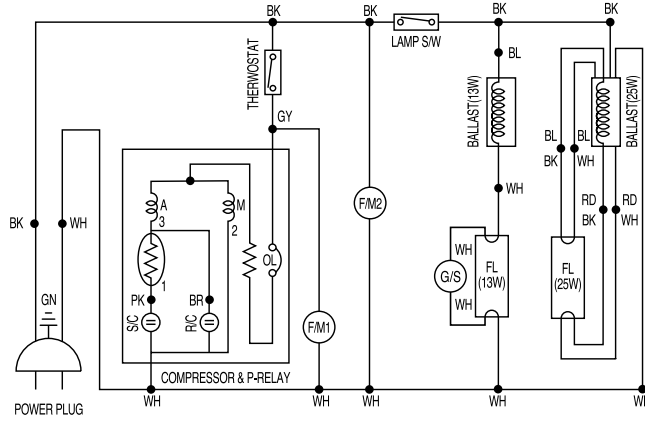

• Model : TGM-11RV

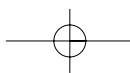
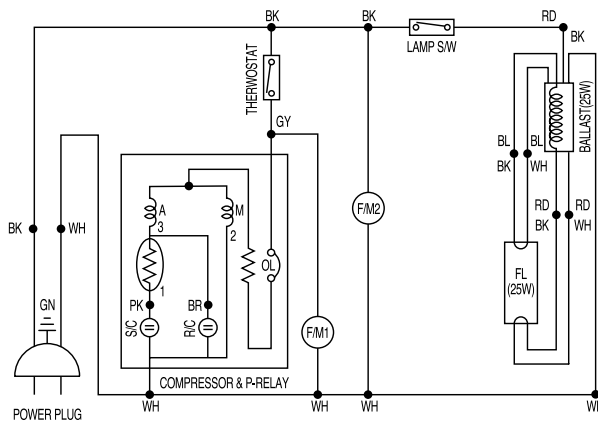

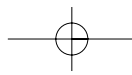

3. REFRIGERANT CYCLE DIAGRAM

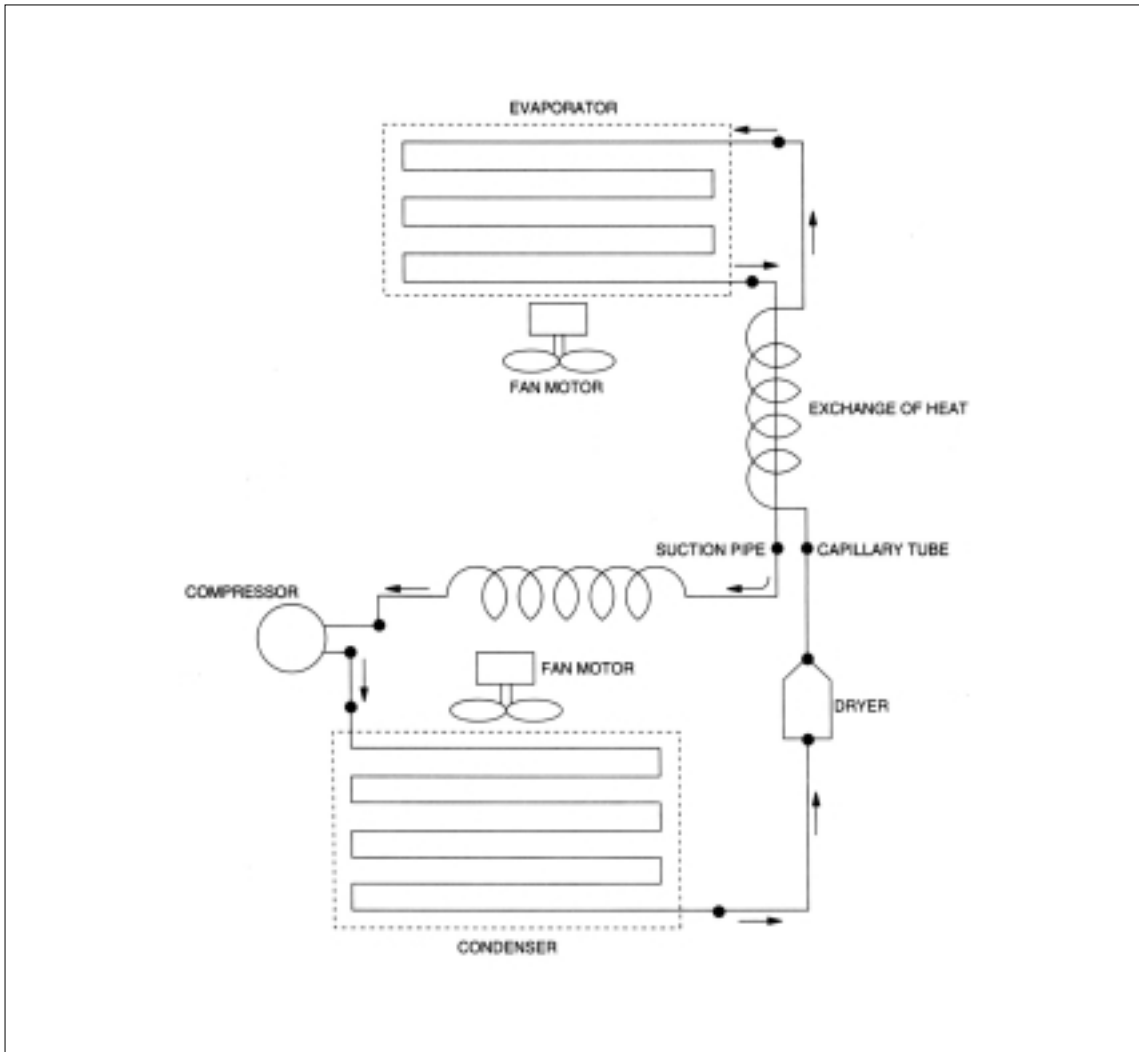

- Refrigerant for all models: R-134a (CFC-Free)

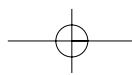

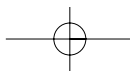

4. SPECIFICATION OF MAIN COMPONENTS

1. COMPRESSOR

MODEL	PART NAME	PART NO.	HORSE POWER	CAPACITY	TYPE OF MOTOR	INPUT	MAKER
TGM69R	AKA4482YXA	30200K2900	3/4 HP	8,200 BTU/h	CSIR	1,190W	TECUMSEH
TGM48R	AKA4476YXA	30200A4700	1/2 HP	7,880 BTU/h (856 Kcal/h)	CSIR	750W	TECUMSEH
TGM45R							
TGM35R							
TGM33R	AEA4448YXA	30200J2100	1/3 HP	4,650 BTU/h	CSIR	457W	TECUMSEH
TGM22R / TGM22RV	HBL27YE-1	3952127G10	1/3 HP	2,080 BTU/h (226 Kcal/h)	CSR	220W	DAEWOO
TGM14R / TGM14RV							
TGM11R / TGM11RV							
TGM5R	HFL11Y-1	3953111E10	1/10 HP	874 BTU/h (95Kcal/h)	RSIR	107W	DAEWOO

2. COMPRESSOR RELAY, OVERLOAD

MODEL	PART NAME	PART NO.	MAKER	OVERLOAD	PART NO.	MAKER
TGM69R	820ARR2B19	-	TECUMSEH	8300MRAK30	-	TECUMSEH
TGM48R	82498-1	-	TECUMSEH	8300MRAM53	-	TECUMSEH
TGM45R						
TGM35R						
TGM33R	820RR12E72	-	TECUMSEH	8300MRTM75	-	TECUMSEH
TGM22R / TGM22RV	PTC 068	3017906900	DAEWOO	4TM-783RHB	3817908600	TEXAS INSTRUMENT
TGM14R / TGM14RV				4TM-783SHB	3817910600	
TGM11R / TGM11RV				4TM-293THB	3817906500	
TGM5R						

3. COMPRESSOR CAPACITOR

MODEL	PART NAME	PART NO.	MAKER	RUNNING	PART NO.	MAKER
TGM69R	-	-	-	-	-	-
TGM48R	125V 378~445MFD	-	TECUMSEH	-	-	TECUMSEH
TGM45R						
TGM35R						
TGM22R / TGM22RV	220V 100 μ F	401RD35050	DAEWOO	230V 10 μ F	400EL15130	DAEWOO
TGM14R / TGM14RV						
TGM11R / TGM11RV						

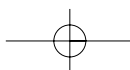

SPECIFICATION OF MAIN COMPONENTS

4. CONDENSER FAN MOTOR

MODEL	PART NAME	PART NO.	POLE	INPUT	TYPE	BLADE (NUMBER)	MAKER
TGM69R	IS-4420DWSG-1	3963220410	4P	47W	Shaded Pole Induction	Aluminum (5)	SUNGSHIN
TGM48R							
TGM45R							
TGM35R							
TGM33R							
TGM22R / TGM22RV	IS-4420DWSR-1	3963229000	4P	47W	Shaded Pole Induction	Aluminum (5)	SUNGSHIN
TGM14R / TGM14RV TGM11R / TGM-11RV	IS-3225DWSQ-2	3963326710	2P	36W	Shaded Pole Induction	Zytel (6)	SUNGSHIN

5. EVAPORATOR FAN MOTOR

MODEL	PART NAME	PART NO.	POLE	INPUT	TYPE	BLADE (NUMBER)	MAKER
TGM69R	IS-4420DWSN-2A	396328120	4P	43W	Shaded Pole Induction	Aluminum (5)	SUNGSHIN
TGM48R	IS-3220DWSF	3963220501	2P	18W	Shaded Pole Induction	Zytel (3)	SUNGSHIN
TGM45R	IS-3225DWSL-1	3963329510	2P	18W	Shaded Pole Induction	Zytel (6)	SUNGSHIN
TGM35R	IS-3220DWSF	3963220501	2P	18W	Shaded Pole Induction	Zytel (3)	SUNGSHIN
TGM33R	IS-3225DWSL-1	3963329510	2P	18W	Shaded Pole Induction	Zytel (6)	SUNGSHIN
TGM22R TGM22RV	IS-3210DWSB-2	3963328610	2P	16W	Shaded Pole Induction	ABS (4)	SUNGSHIN
TGM14R TGM14RV	IS-4420DWSN-2	3963328110	4P	43W	Shaded Pole Induction	Aluminum (5)	SUNGSHIN
TGM11R TGM11RV	IS-3210DWSB-3	3963328620	2P	16W	Shaded Pole Induction	ABS (4)	SUNGSHIN

6. THERMOSTAT

MODEL	PART NAME	PART NO.	TYPE	MAKER
TGM69R	K55-Q5606	30283K0110	C.C.I	RANCO
TGM48R	K55-Q5605	30283K0100	C.C.I	RANCO
TGM45R TGM35R TGM33R	K55-Q5602	30283D0700	C.C.I	RANCO
TGM22R / TGM22RV TGM14R / TGM14RV TGM11R / TGM11RV				
TGM5R	PFN-110U-02D	3018301001	NORMAL	PACIFIC SHINHAN
	GNF-110U-02D		NORMAL	

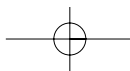

SPECIFICATION OF MAIN COMPONENTS

7. BALLAST

MODEL	PART NAME		PART NO.	QTY	WATT	CURRENT	TYPE
	ADVANCE	MAGNETEK					
TGM69R	R-2P32-TP	M232SR120C	30285D0500	2	32W	0.61A	Rapid
TGM48R	R-2P32-TP	M-232SR120C	30285D0500	1	32W	0.61A	Rapid
TGM45R	R-1P32-TP	M-132R120C	30285A0700	1	32W	0.32A	Rapid
	R-2P825-TP	731-L-TC-P	30285J1200	1	25W	0.30A	Rapid
TGM35R	R-1P32-TP	M-132R120C	30285A0700	1	32W	0.32A	Rapid
	R-1P825-TP	727-L-TC-P	30285J1200	1	25W	0.30A	Rapid
TGM33R	R-1P32-TP	M-132R120C	30285A0700	1	32W	0.32A	Rapid
	R-2P817-TP	701-L-TC-P	30285H1500	1	17W	0.39A	Rapid
TGM22R	R-2P817-TP	701-L-TC-P	30285H1500	1	17W	0.39A	Rapid
	R-1P32-TP	M-132R120C	30285A0700	1	32W	0.32A	Rapid
TGM22RV	R-1P817TP	703-L-TC-P	30200H7400	1	17W	0.21A	Rapid
TGM14R	DD22B (MAKER : DONGDO)		30200A0140	2	13W	0.28A	Preheated
TGM14RV	R-1P825-TP	727-L-TC-P	30285J1200	1	25W	0.30A	Rapid
	DD22B (MAKER DONGDO)		30200A0140	1	13W	0.28A	Preheated
TGM11R	DD22B (MAKER : DONGDO)		30200A0140	1	13W	0.28A	Preheated
TGM11RV	R-1P825-TP	727-L-TC-P	30285J1200	1	25W	0.30A	Rapid
TGM5R	DD22B (MAKER : DONGDO)		30200A0140	1	13W	0.28A	Preheated

8. FLUORESCENT LAMP

MODEL	PART NAME	PART NO.	QTY	WATT	LENGTH	DESCRIPTION	BULB	MAKER
TGM69R	F32T8/TL850	30200D2800	4	32W	48"	TL80, 5000K	T8	PHILIPS or GE
TGM48R	F32T8/TL850	30200D2800	2	32W	48"	TL80, 5000K	T8	
TGM45R	F32T8/TL850	30200D2800	1	32W	48"	TL80, 5000K	T8	
	F25T8/TL950	30236A0500	2	25W	36"	TL80, 5000K	T8	
TGM35R	F32T8/TL850	30200D2800	1	32W	48"	TL80, 5000K	T8	
	F25T8/TL950	30236A0500	1	25W	36"	TL80, 5000K	T8	
TGM33R	F32T8/TL850	30200D2800	1	32W	48"	TL80, 5000K	T8	
	F17T8/TL950	30236H0500	2	25W	36"	TL80, 5000K	T8	
TGM22R	F17T8/TL950	30236H0500	2	17W	24"	TL80, 5000K	T8	
TGM22RV	F32T8/TL850	30200D2800	1	32W	48"	TL80, 5000K	T8	
	F17T8/TL950	30236H0500	1	17W	24"	TL80, 5000K	T8	
TGM14R	F13T8/CW	30236F0500	2	13W	12"	COOL WHITE, 4100K	T8	
TGM14RV	F28T8/TL950	30236A0500	1	25W	36"	TL80, 5000K	T8	
	F13T8/CW	30236F0500	1	13W	12"	COOL WHITH, 4100K	T8	
TGM11R	F13T8/CW	30236F0500	1	13W	12"	COOL WHITE, 4100K	T8	
TGM11RV	F28T8/TL950	30236A0500	1	25W	36"	TL80, 5000K	T8	
TGM5R	F13T8/CW	30236F0500	1	13W	12"	COOL WHITE, 4100K	T8	

9. LIGHT STATER

MODEL	PART NAME	PART NO.	BASE	MAKER
TGM14R / TGM14RV	FS-2	30236A0700	P21	OPO
TGM11R				
TGM5R				

10. LAMP SWITCH

MODEL	TYPE	PART NO.	RATING	MAKER
ALL	ROCKER SWITCH	30281A0600	125V, 6A	DAESUNG

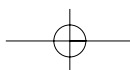

5. TROUBLE SHOOTING CHART

1. THE REFRIGERATOR DOES NOT COOLING

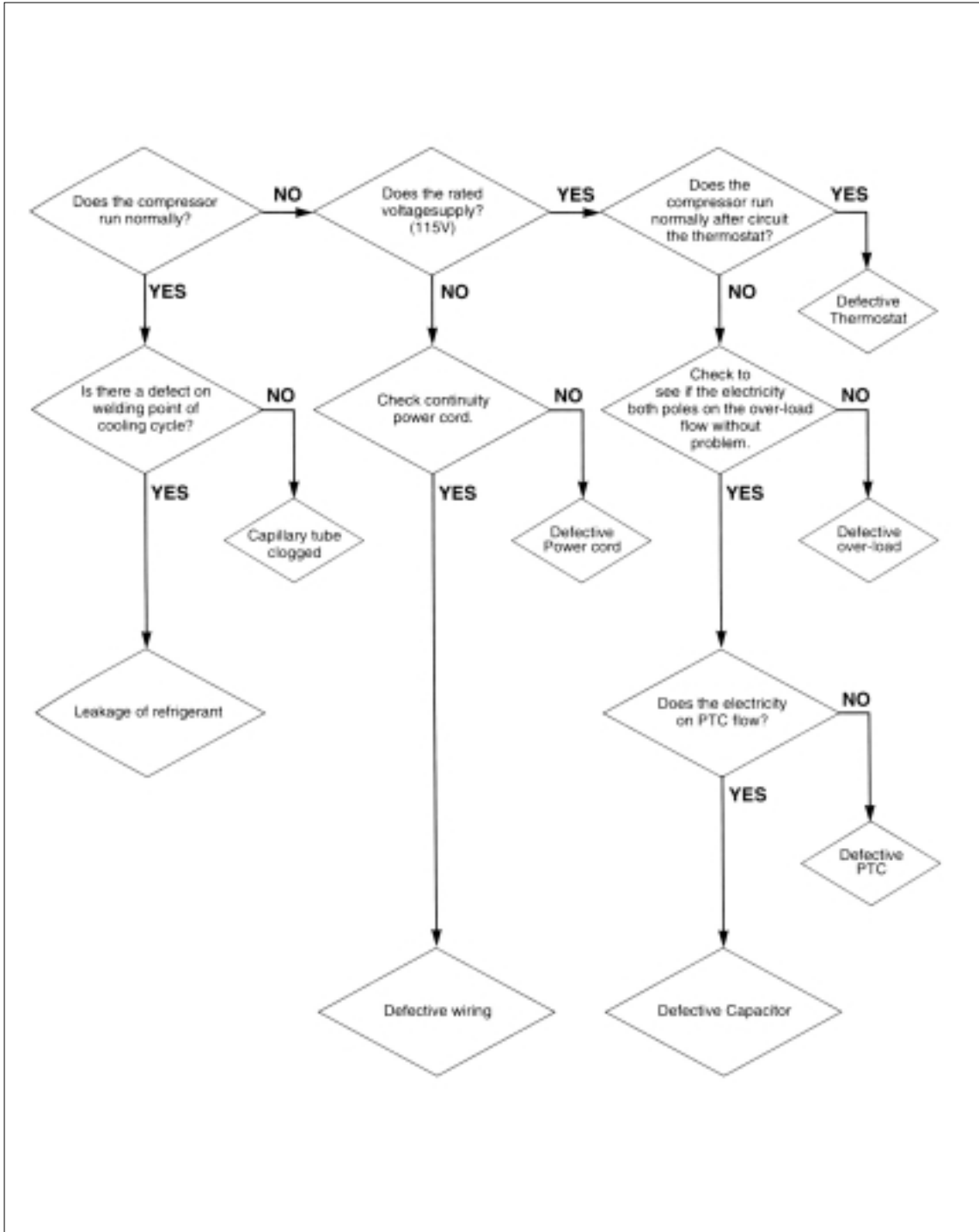

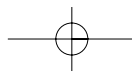

TROUBLE SHOOTING CHART

2. THE REFRIGERATOR DOES NOT COOLING WELL

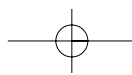
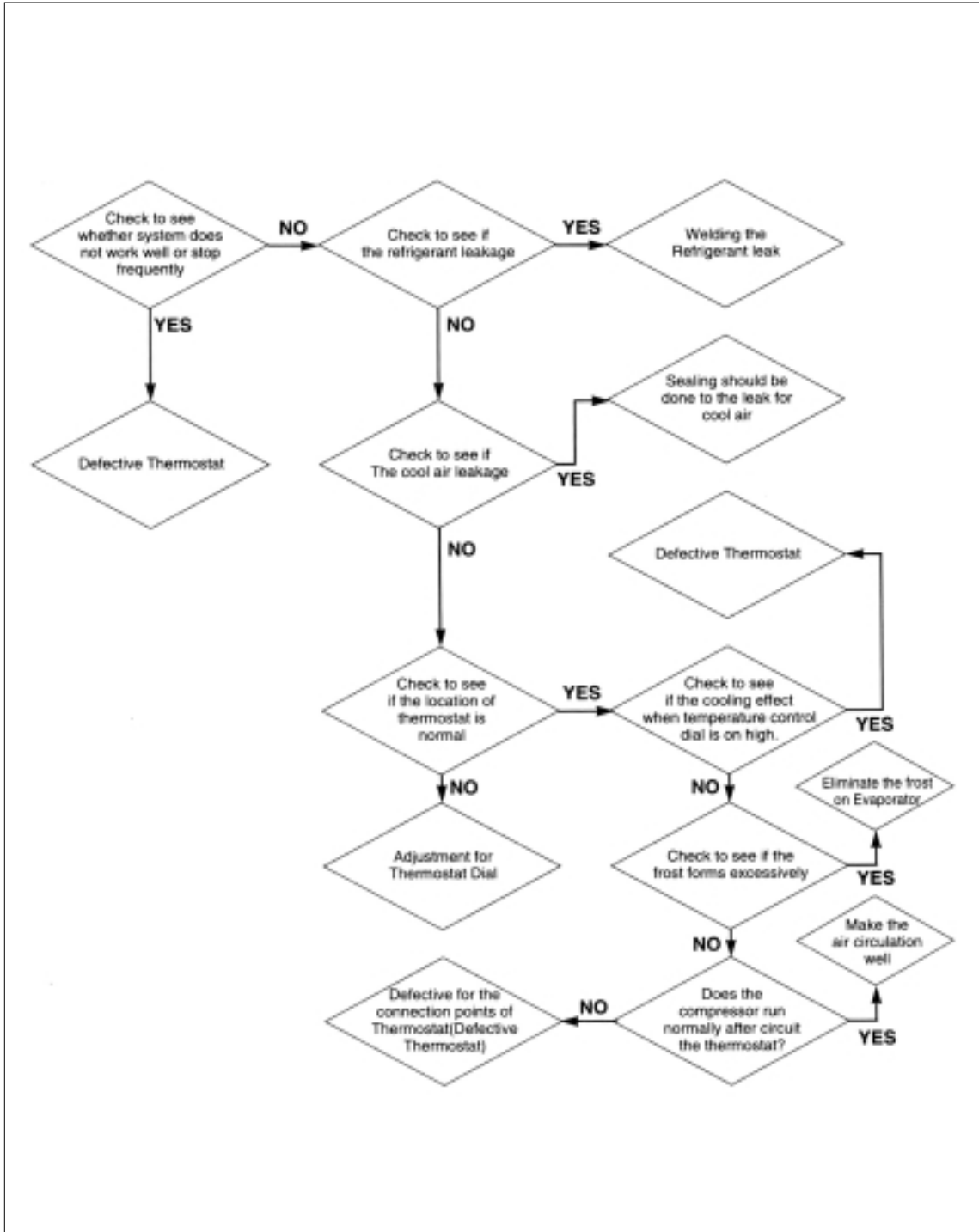

TROUBLE SHOOTING CHART

3. LAMP DOES NOT LIGHT WELL

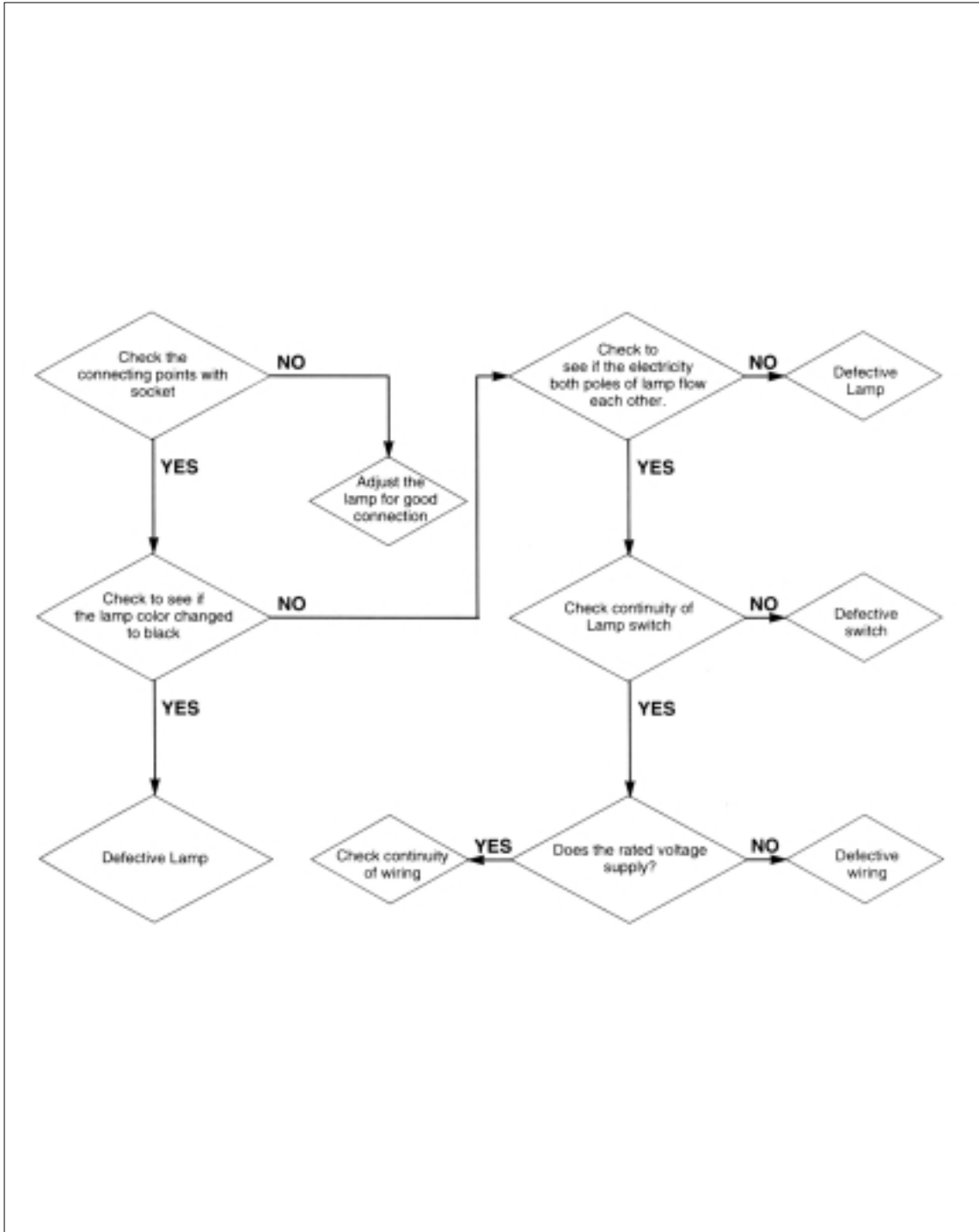

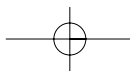

TROUBLE SHOOTING CHART

4. WHEN THERE IS AN EXCESSIVE NOISE

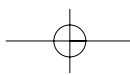
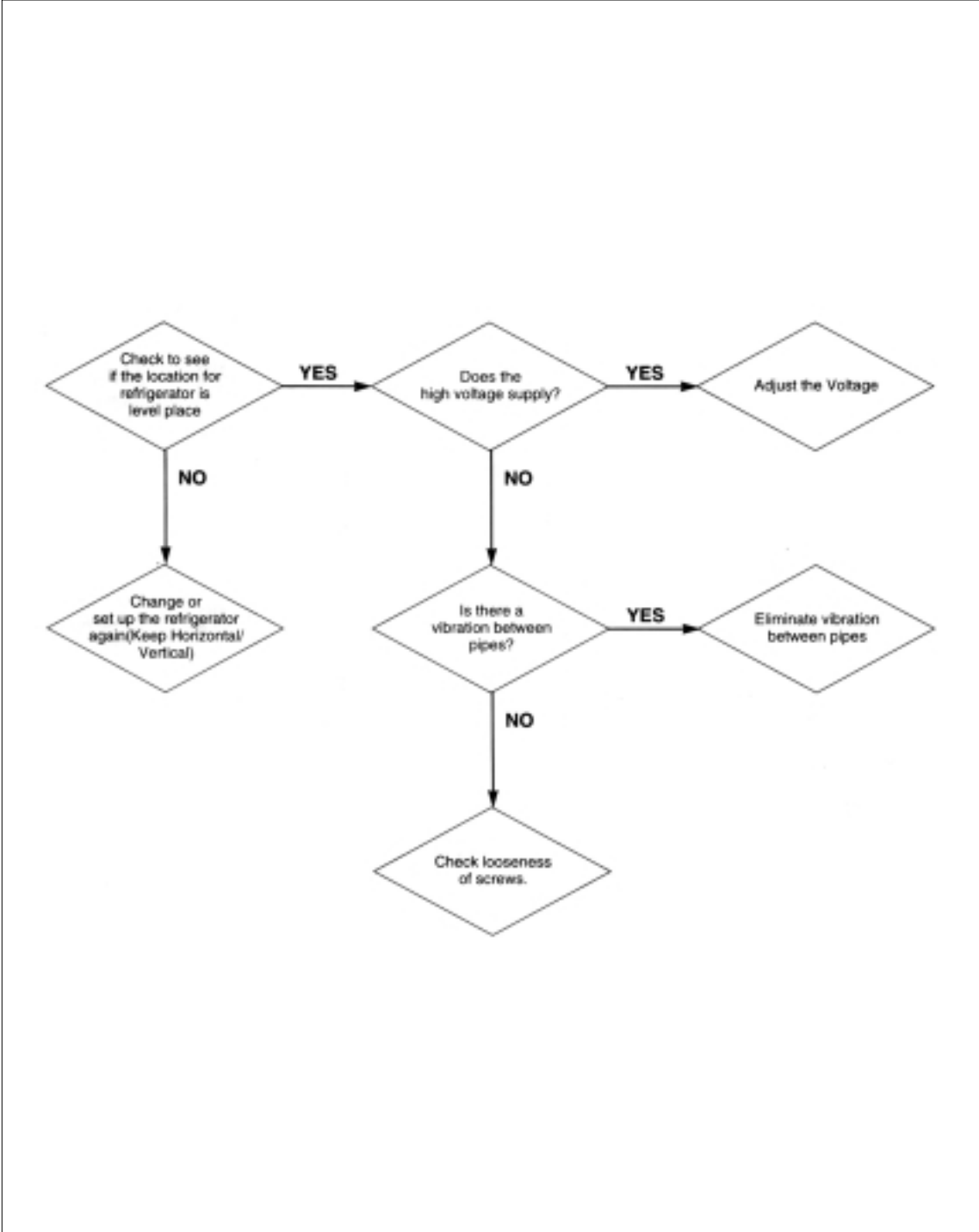

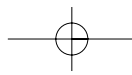

6. PARTS DIAGRAM

1. CASTER or LEVELING LEG PARTS

•Model : TGM-69R, 48R, 45R, 35R, 33R, 22R, 14R, 14RV (Option)

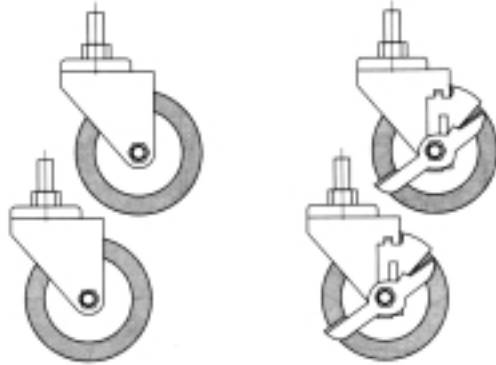

Caster



LEVELING LEG
(TGM-14R,
14RV,11R, 11RV)



LEVELING LEG
(TGM-5R)

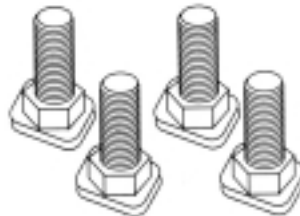

LEVELING LEG
(TGM-69R, 48R, 45R, 35R, 33R, 22R,
22RV)

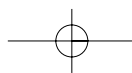

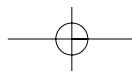

PARTS DIAGRAM

2. COMPRESSOR PARTS

•Model : TGM-69R, 48R, 45R, 35R, 33R

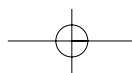
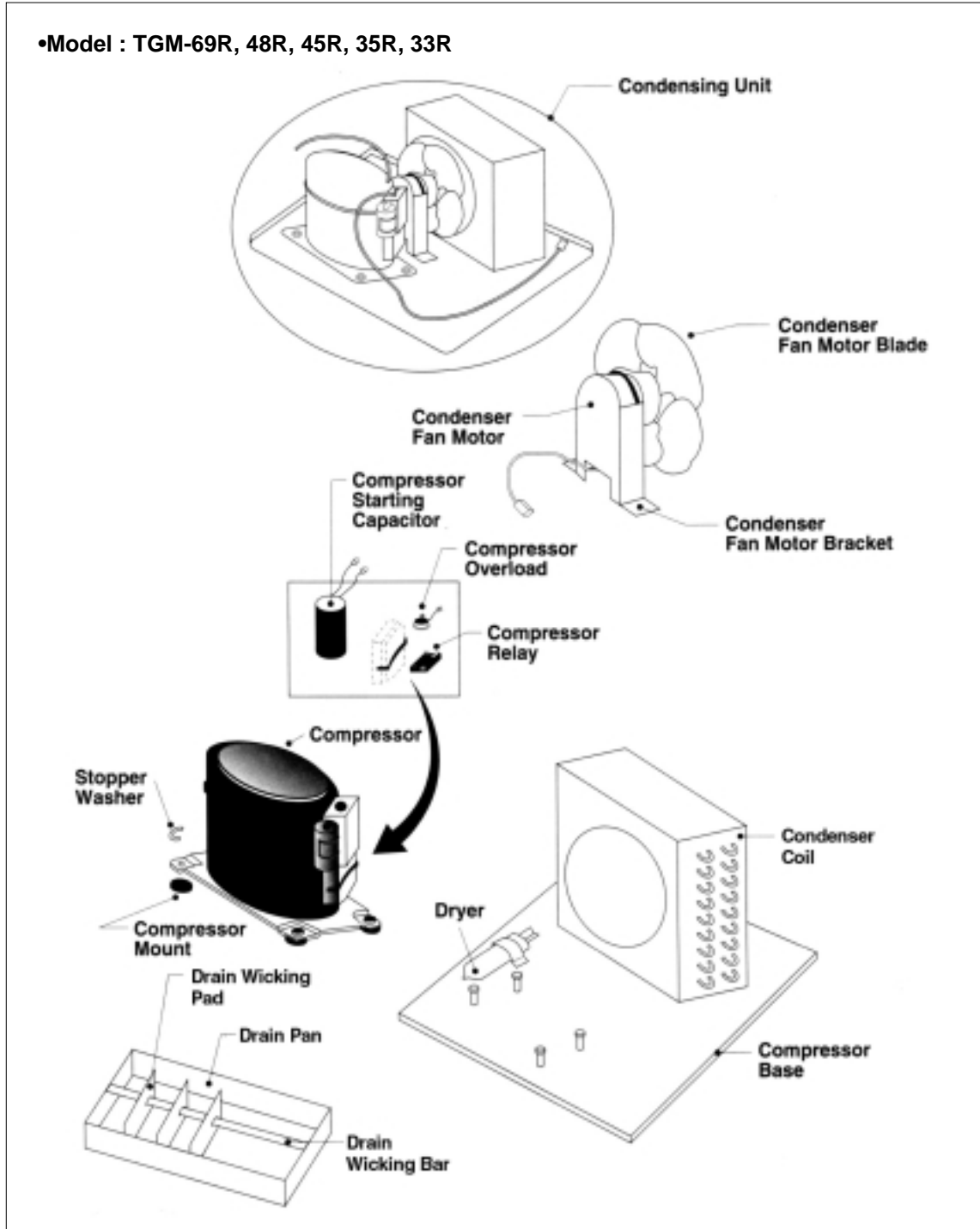

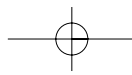

PARTS DIAGRAM

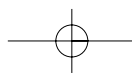
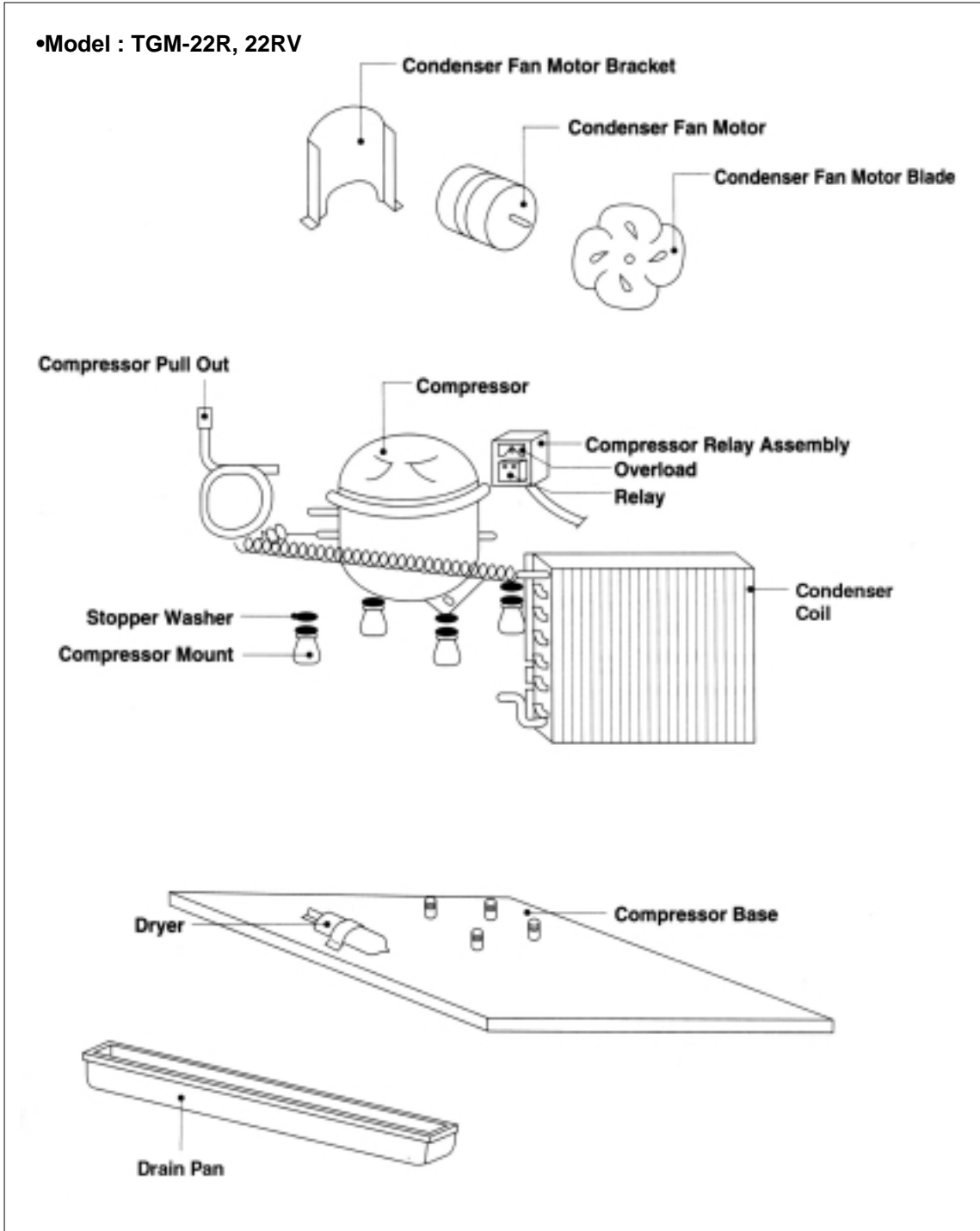

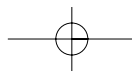

PARTS DIAGRAM

•Model : TGM-14R, 14RV, 11R, 11RV

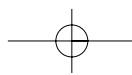
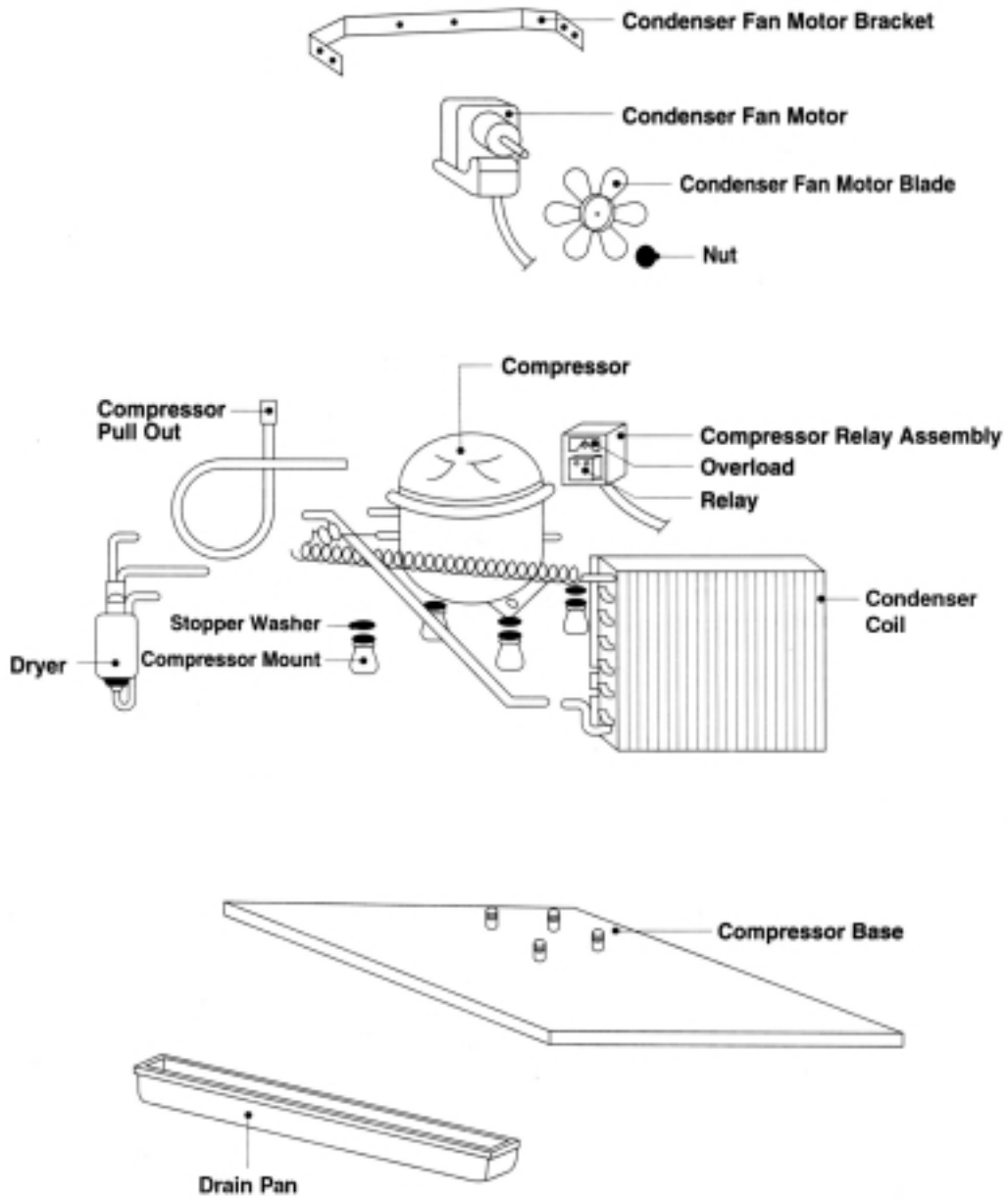

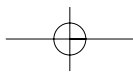

PARTS DIAGRAM

•Model : TGM-5R

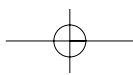
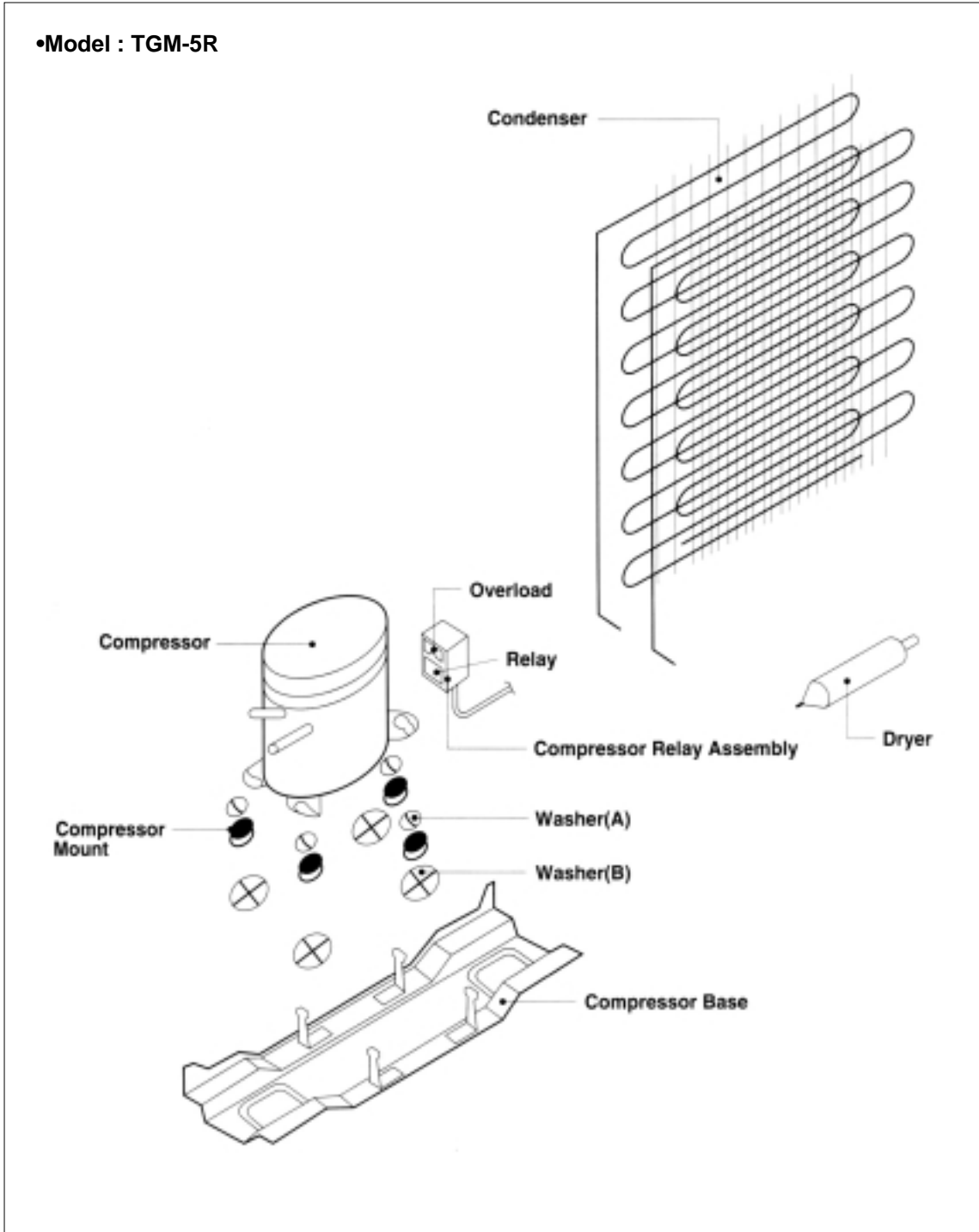

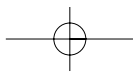

PARTS DIAGRAM

3. DOOR PARTS

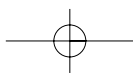
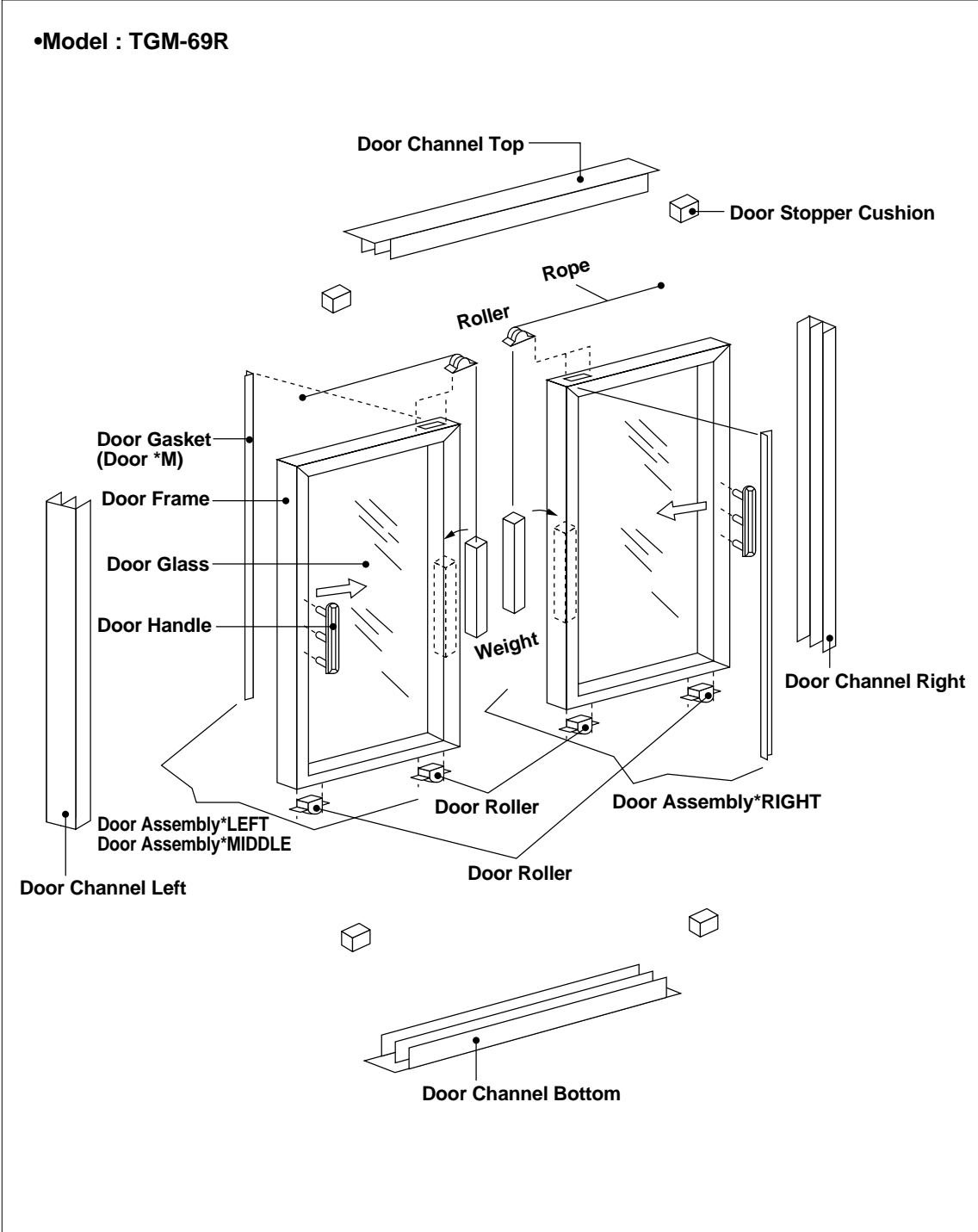

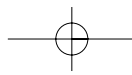

PARTS DIAGRAM

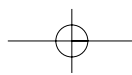
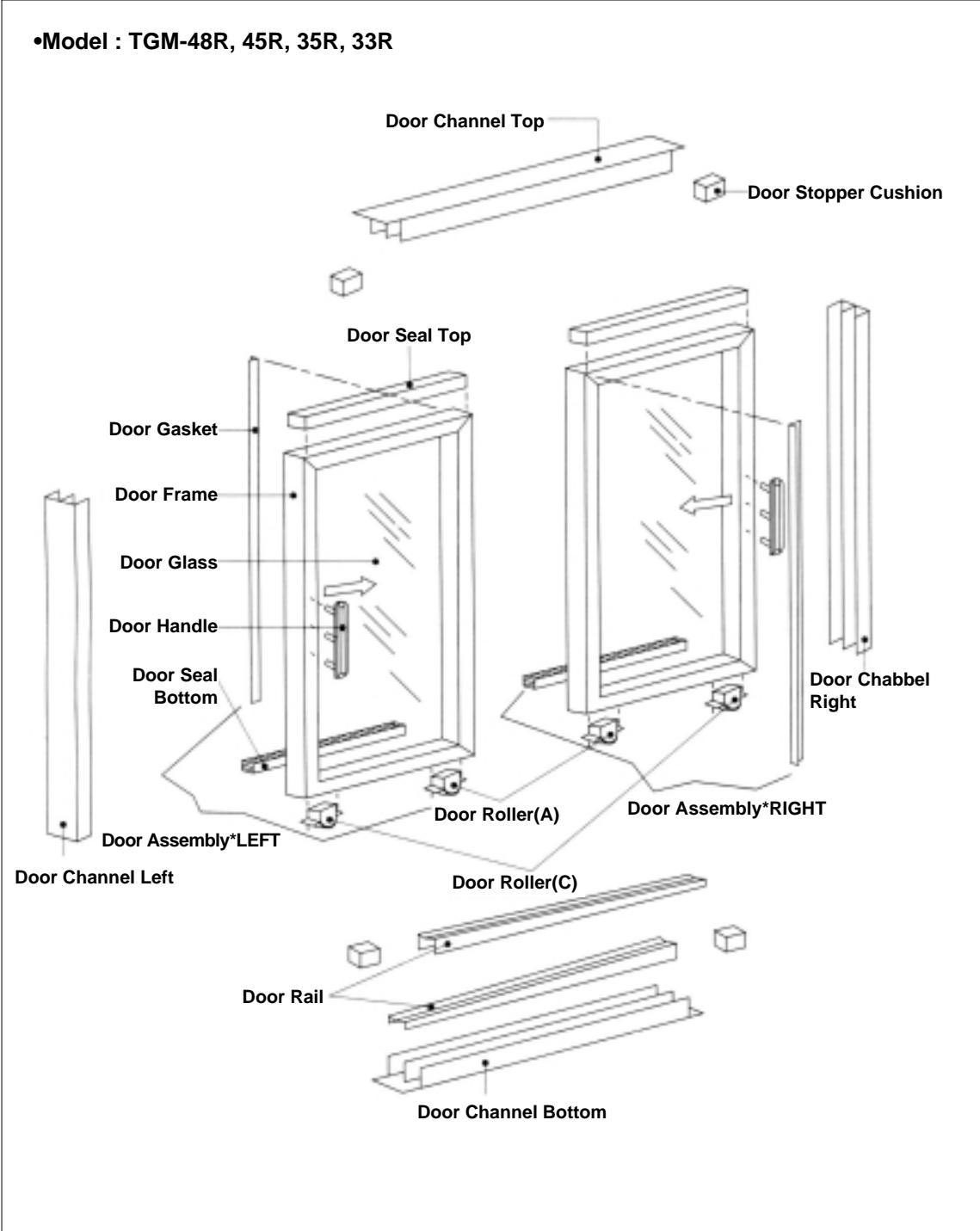

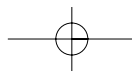

PARTS DIAGRAM

•Model : TGM-22R, 22RV, 14R, 14RV, 11R, 11RV

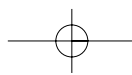
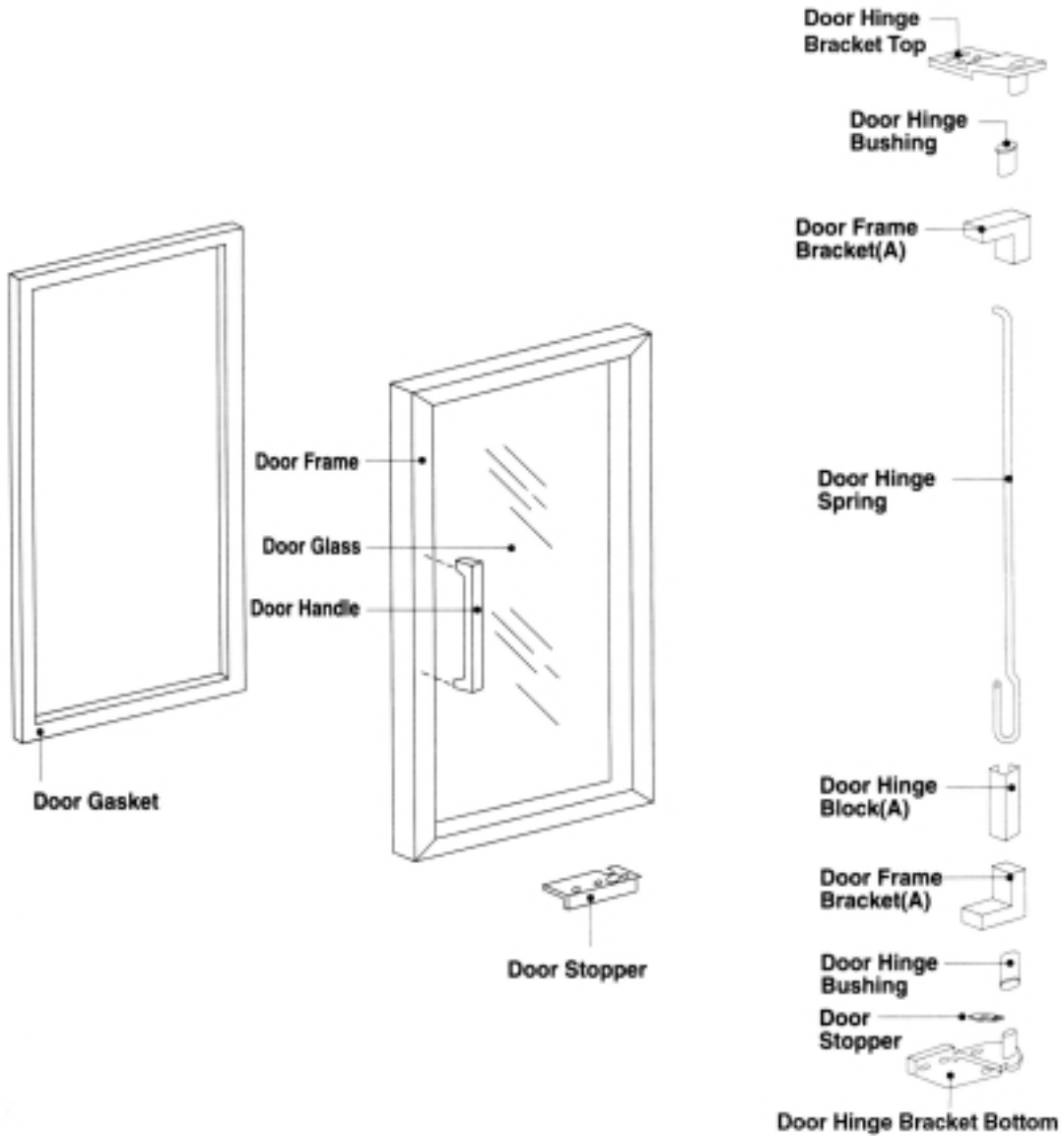

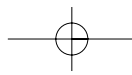

PARTS DIAGRAM

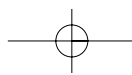
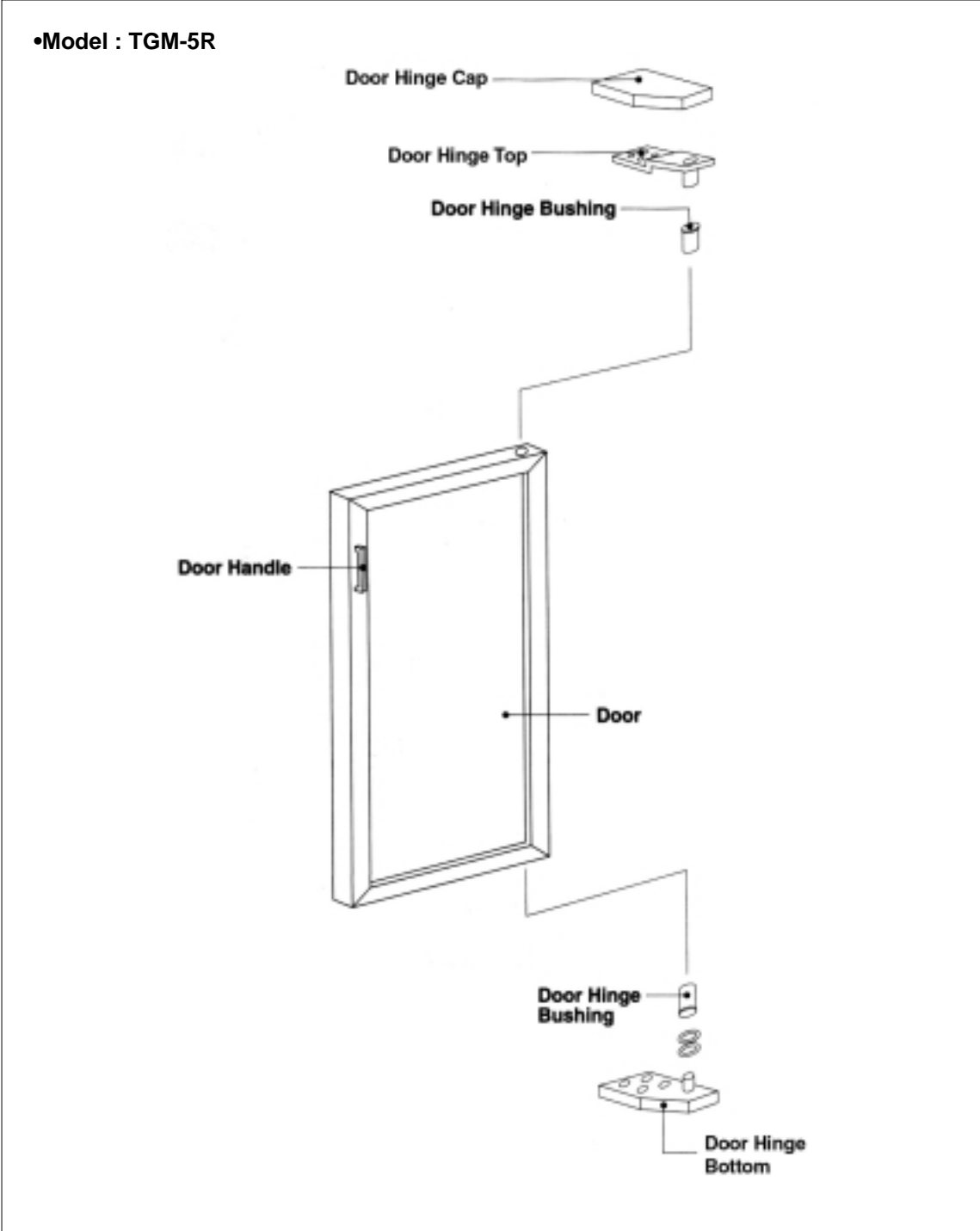

PARTS DIAGRAM**4. EVAPORATOR PARTS**

•Model : TGM-48R, 35R

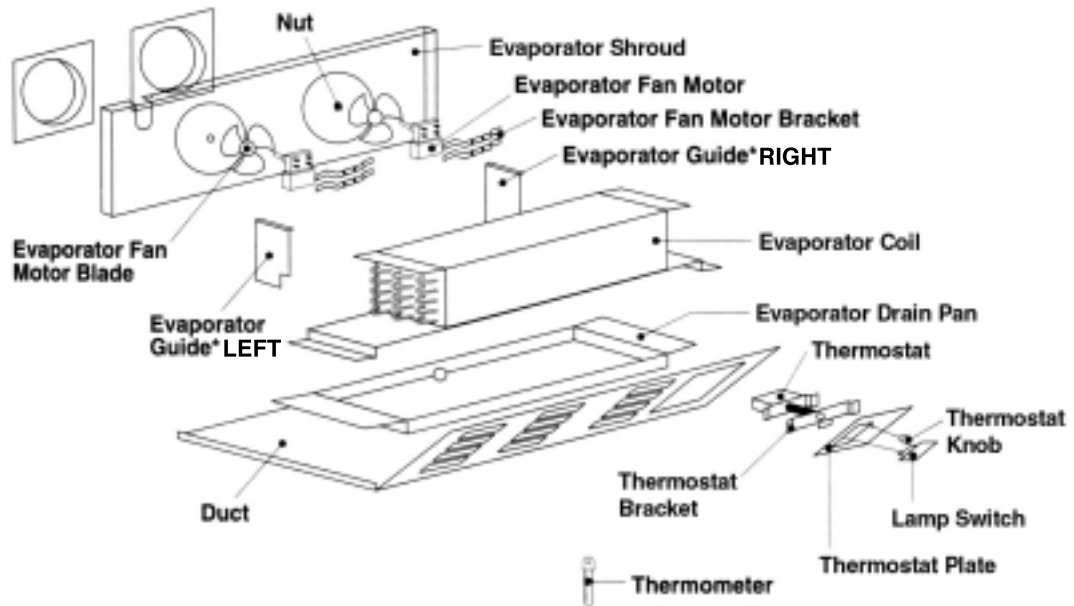

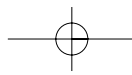

PARTS DIAGRAM

•Model : TGM-69R, 45R, 33R

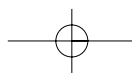
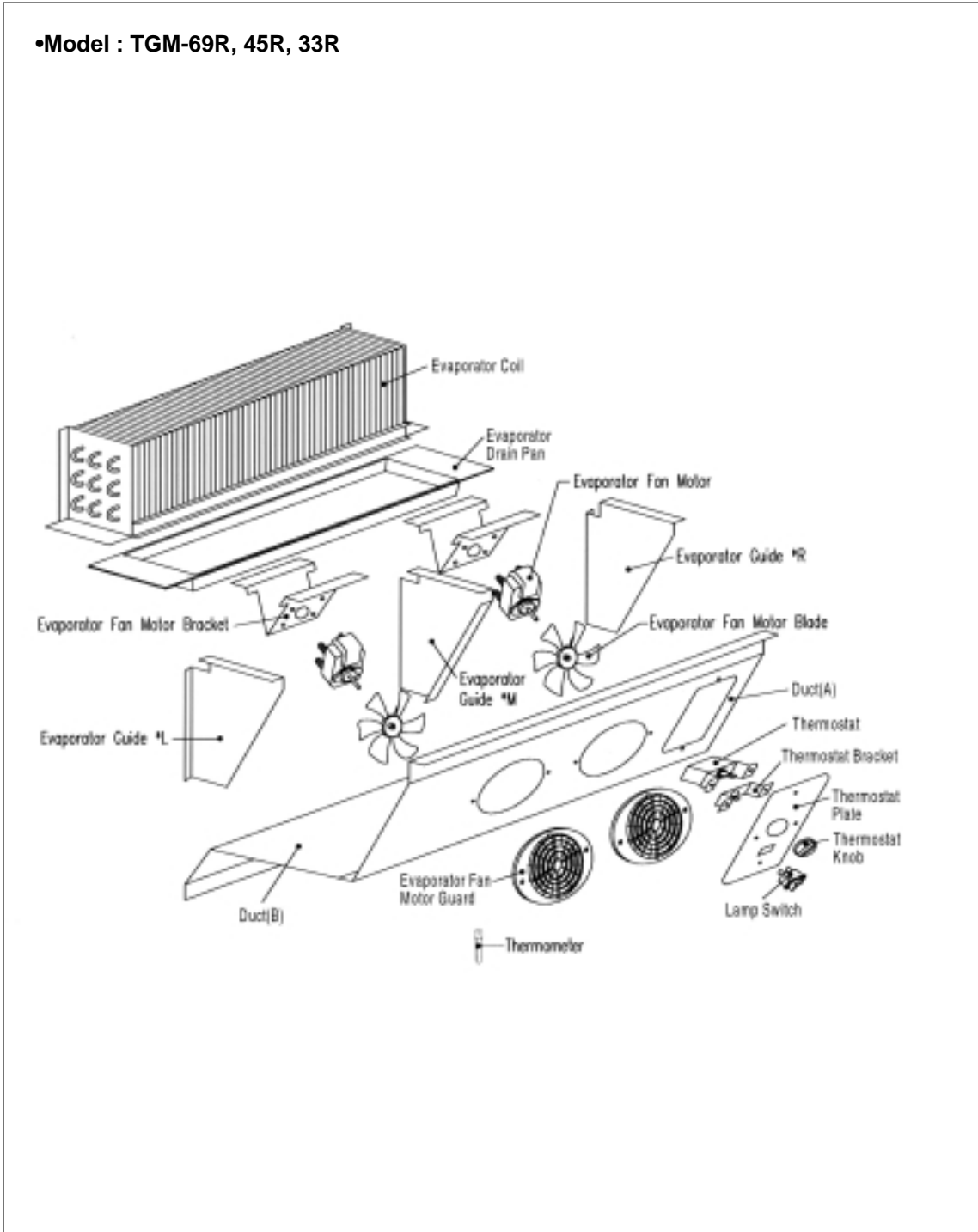

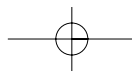

PARTS DIAGRAM

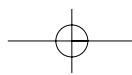
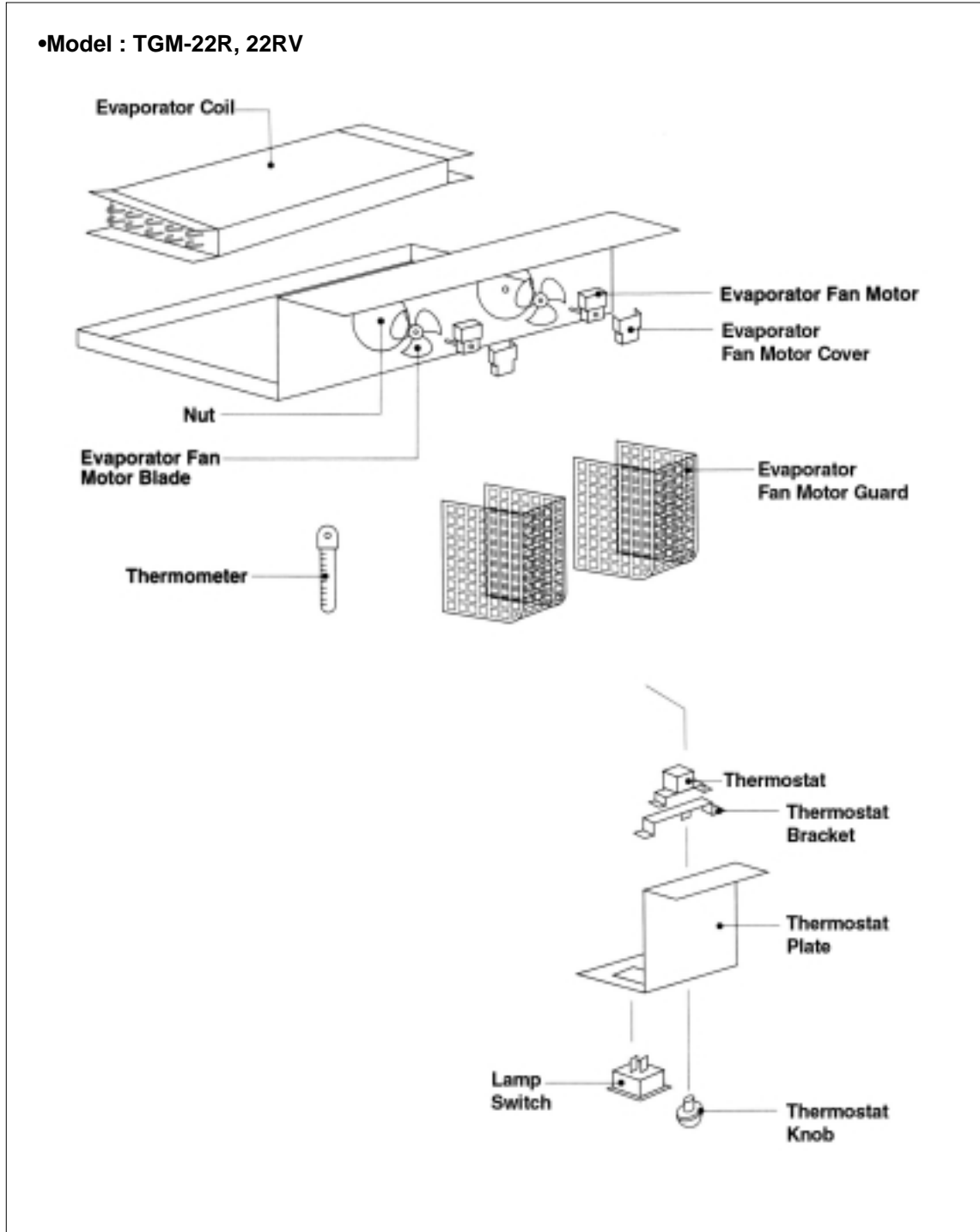

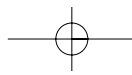

PARTS DIAGRAM

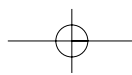
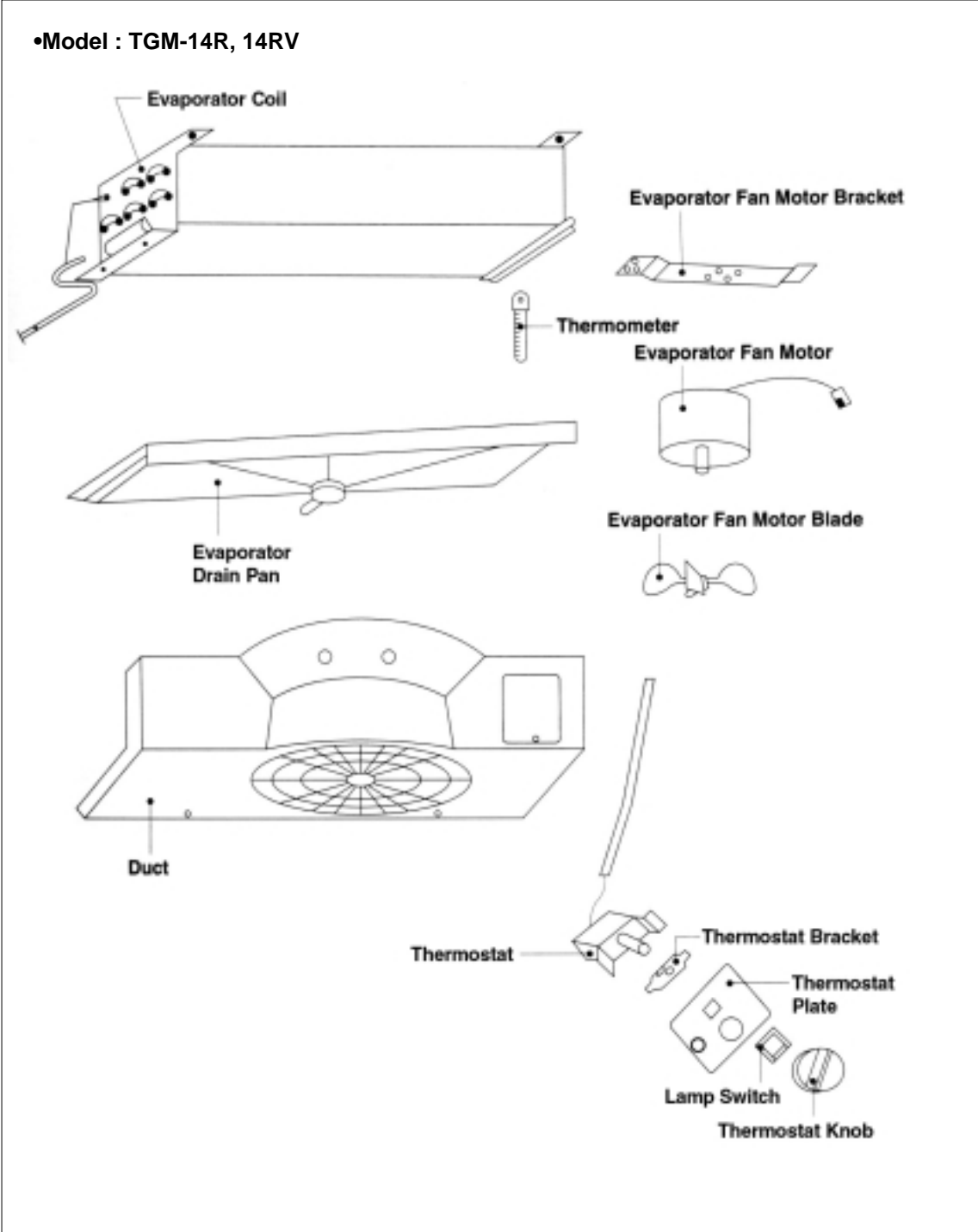

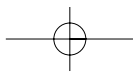

PARTS DIAGRAM

•Model : TGM-11R. 11RV

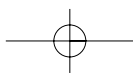
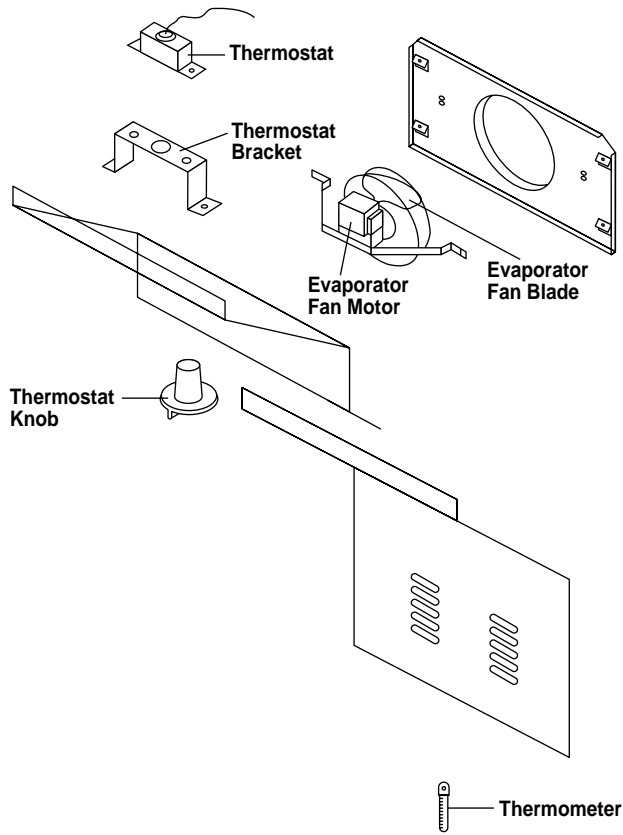

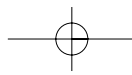

PARTS DIAGRAM

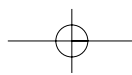
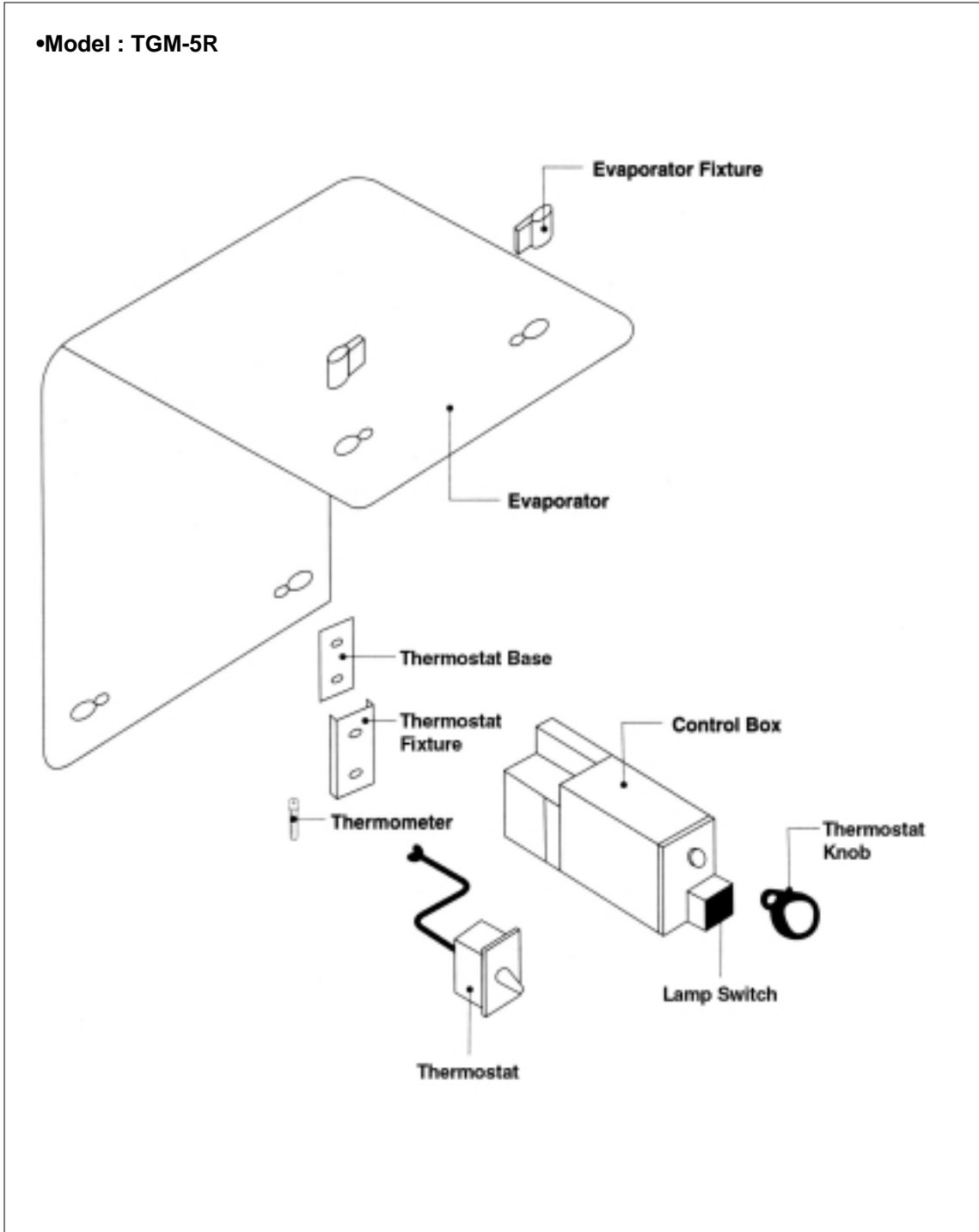

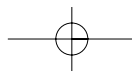

PARTS DIAGRAM

5. LIGHTING PARTS

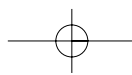
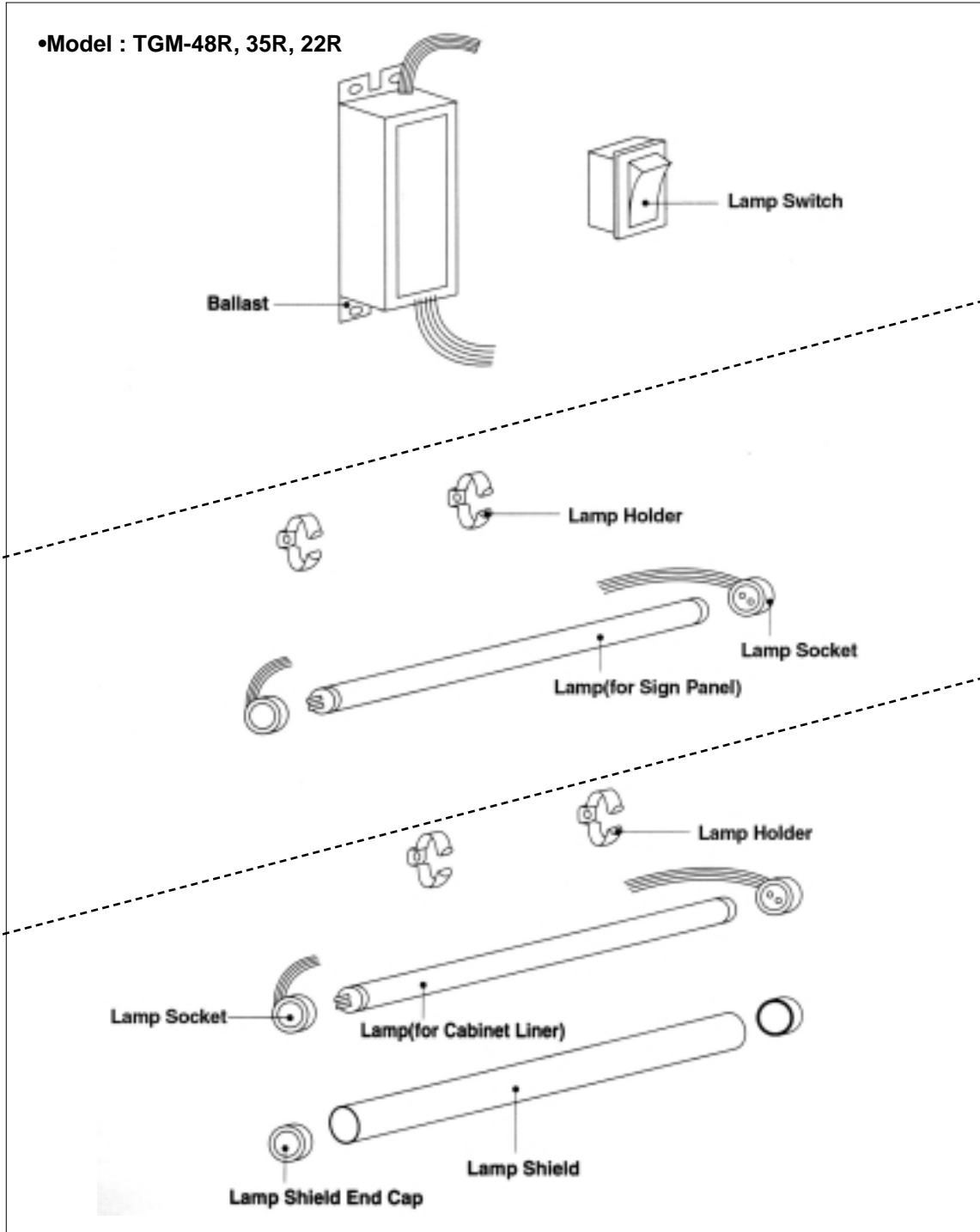

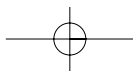

PARTS DIAGRAM

•Model : TGM-69R, 45R, 33R

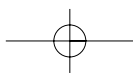
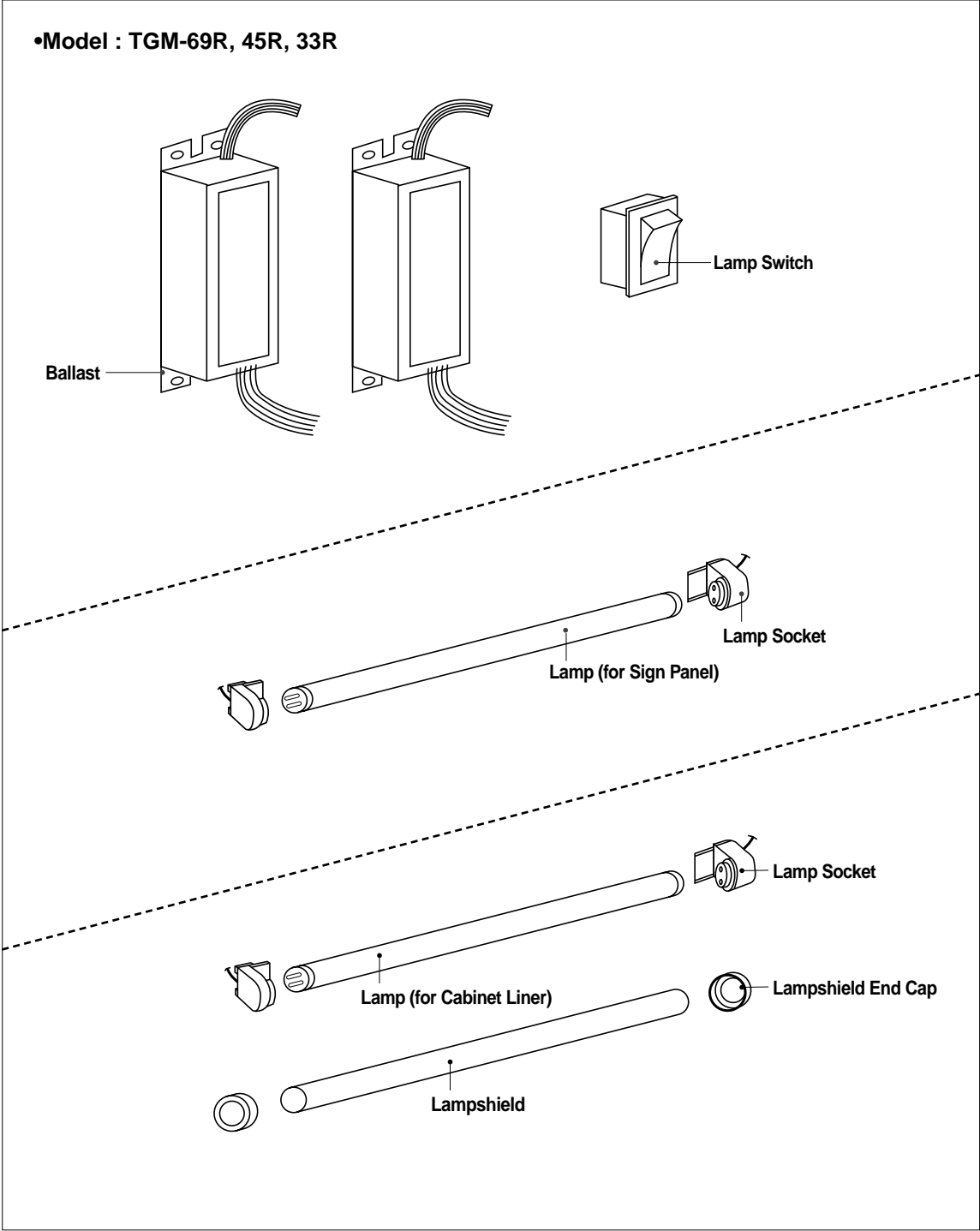

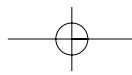

PARTS DIAGRAM

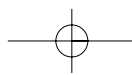
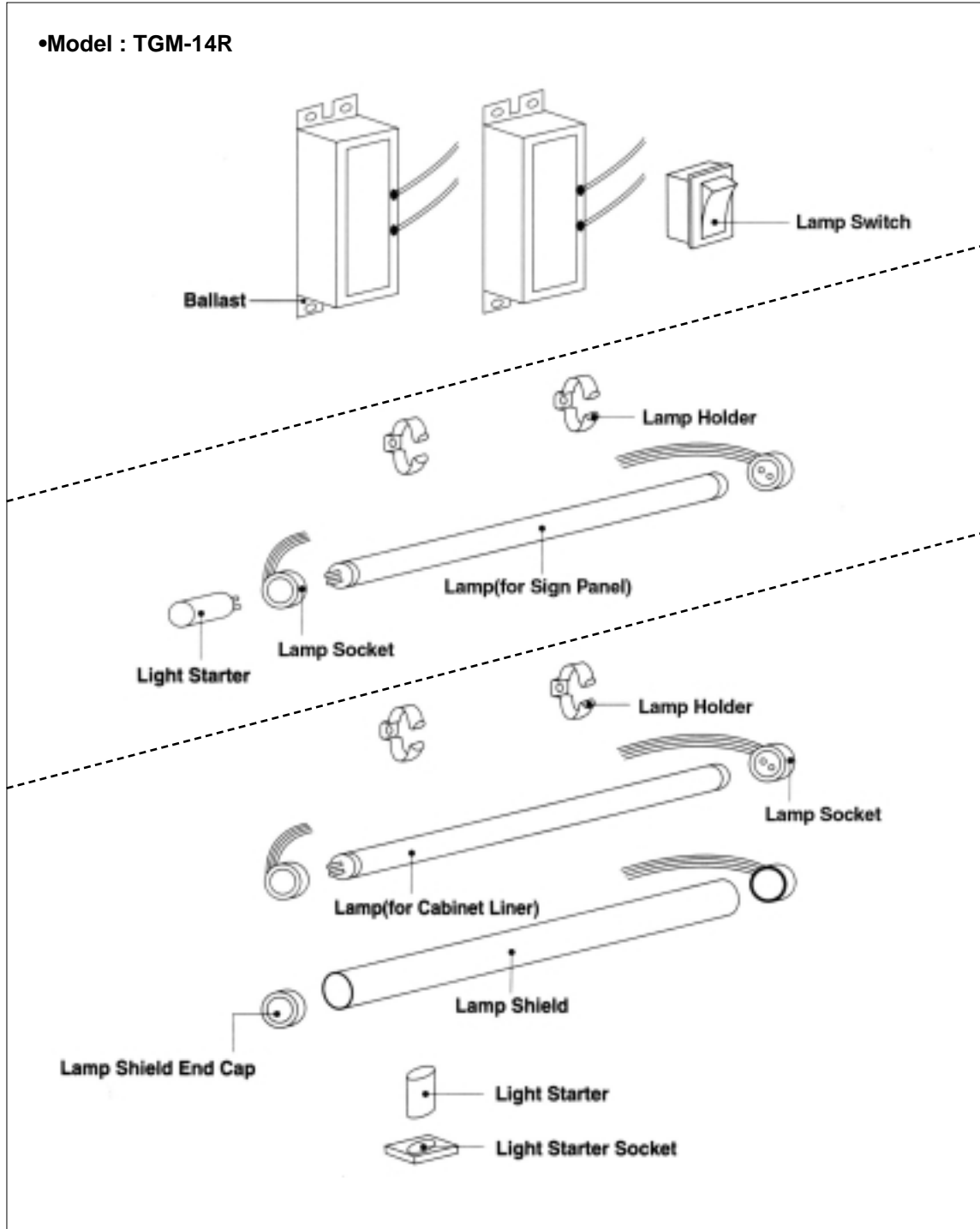

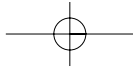

PARTS DIAGRAM

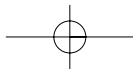
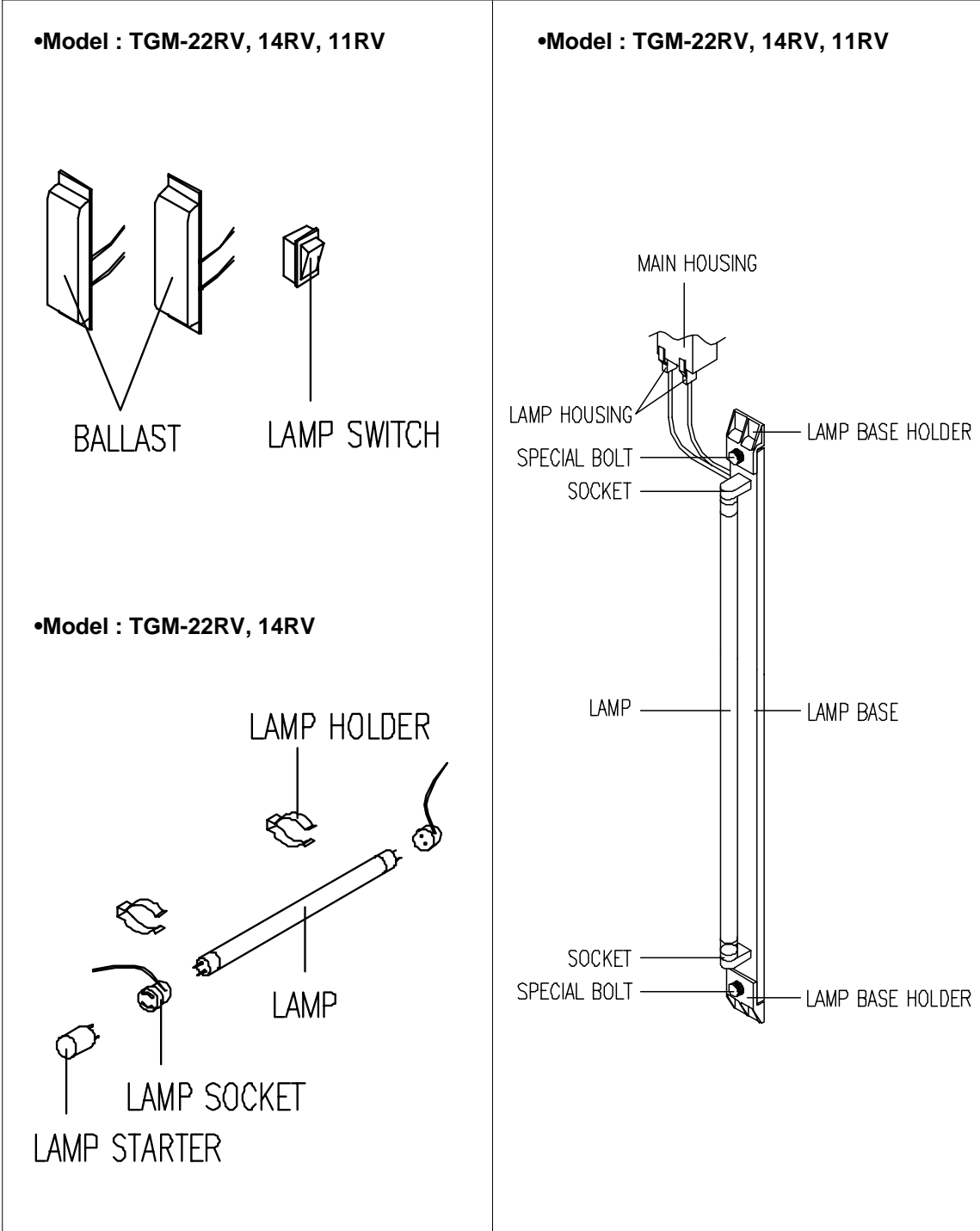

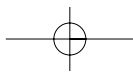

PARTS DIAGRAM

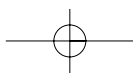
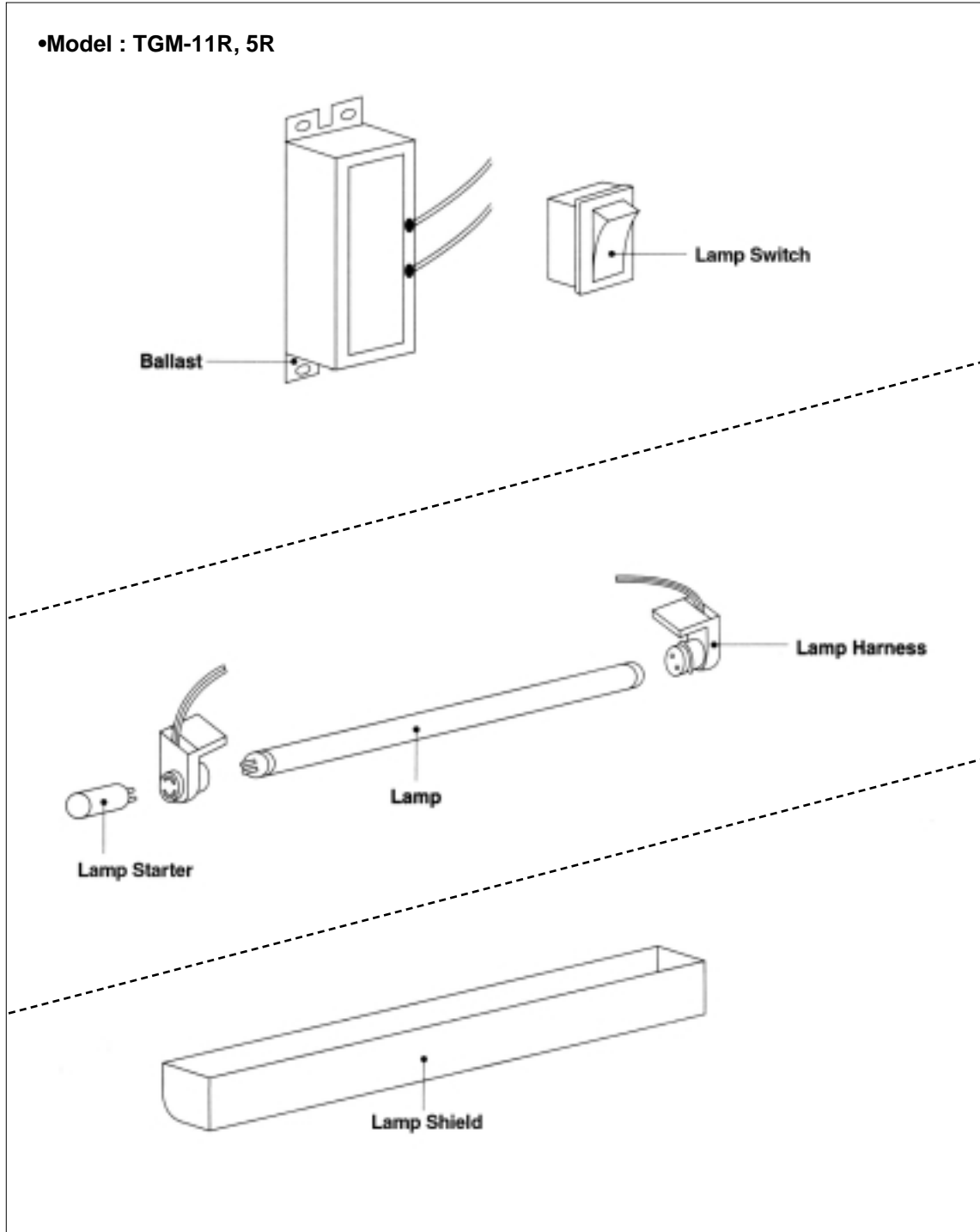

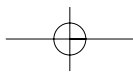

PARTS DIAGRAM

6. SHELF PARTS

•Model : TGM-69R, 48R, 35R

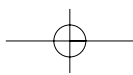
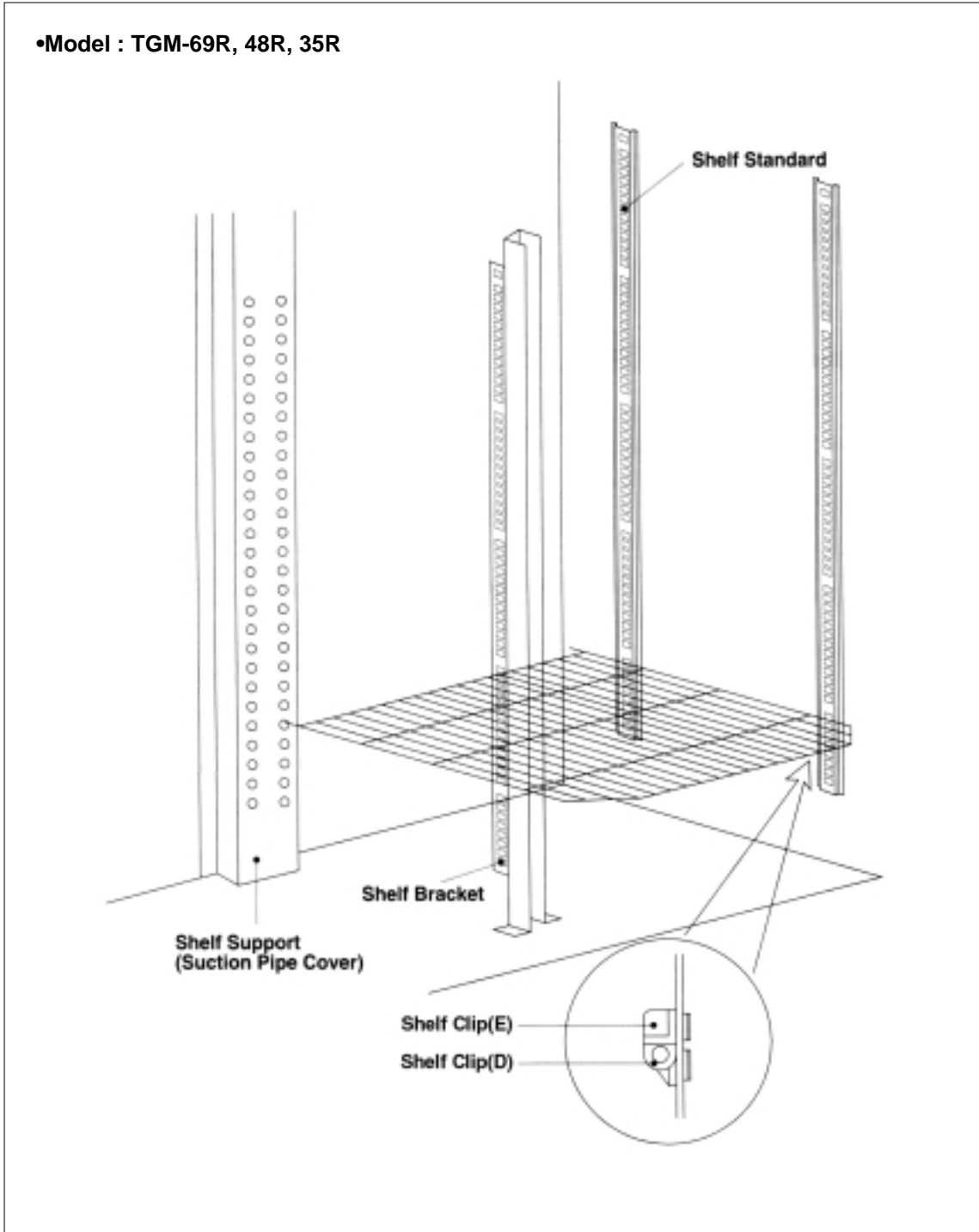

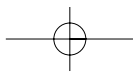

PARTS DIAGRAM

7. ADVERTISING & ADVERTISING FRAME PARTS

•Model : TGM-69R, 48R, 35R

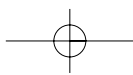
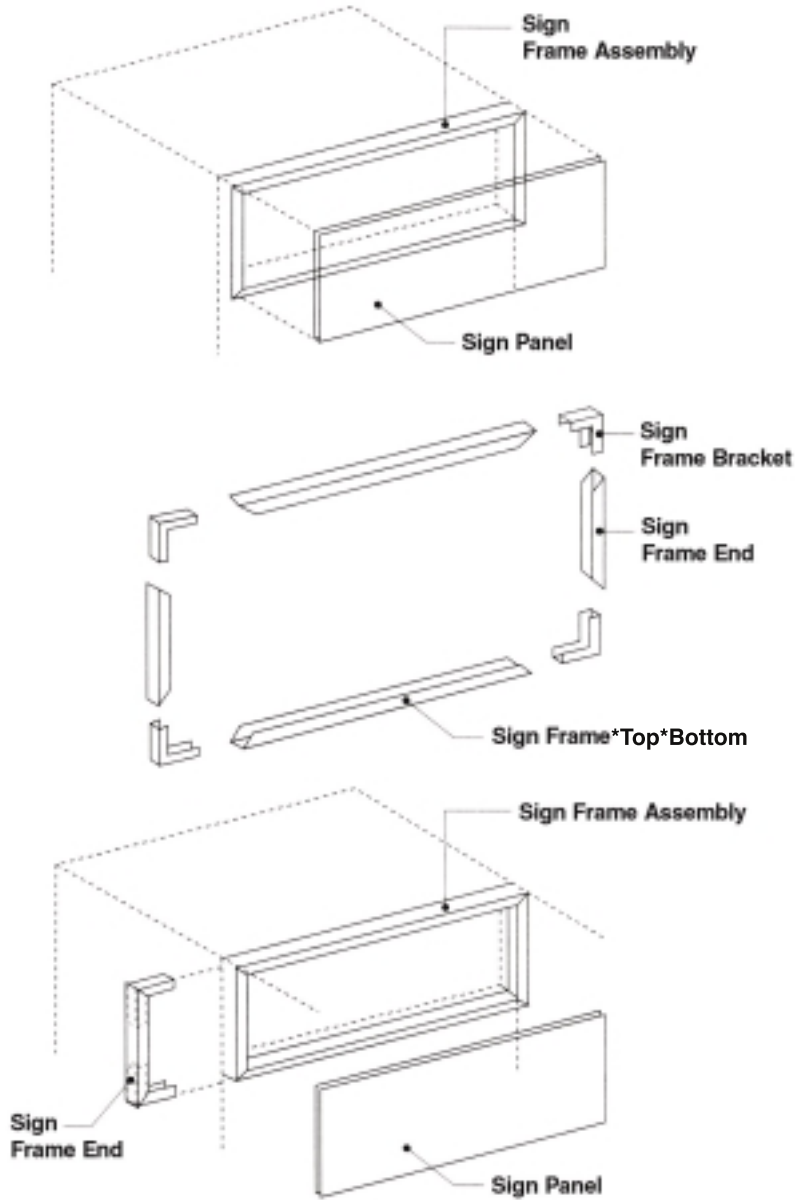

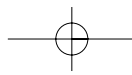

PARTS DIAGRAM

•Model : TGM-45R, 33R, 22R, 22RV, 14R, 14RV

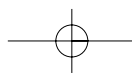
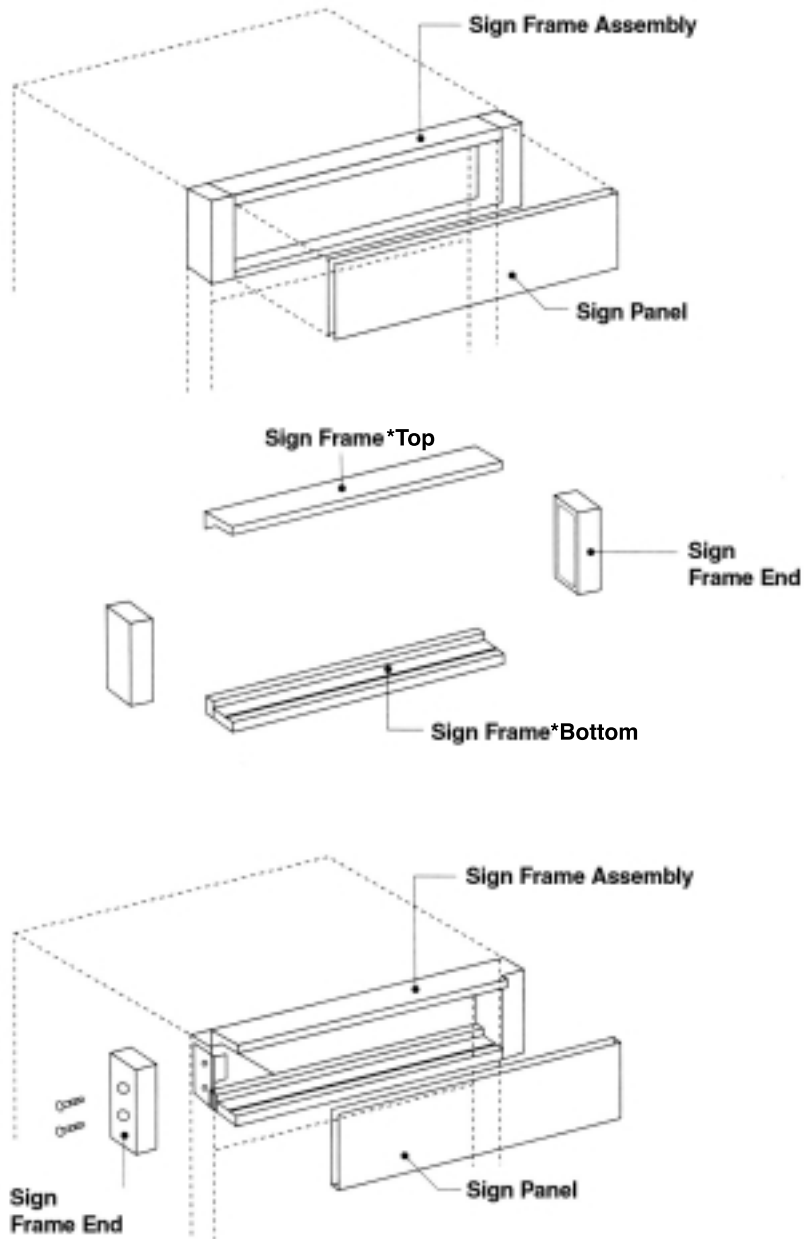

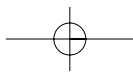

PARTS DIAGRAM

8. GRILL PARTS

•Model : TGM-69R, 48R, 45R, 35R, 33R



•Model : TGM-22R, 22RV

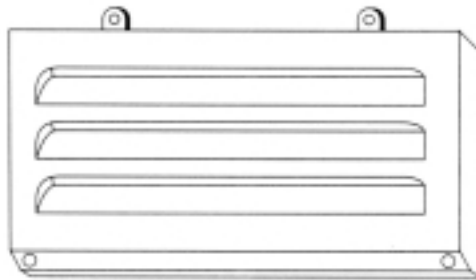

•Model : TGM-14R, 14RV, 11R, 11RV

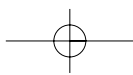

PARTS DIAGRAM

9. HOW TO REPLACE THE THERMOSTAT

•Model : TGM-69R

How to replace the THERMOSTAT

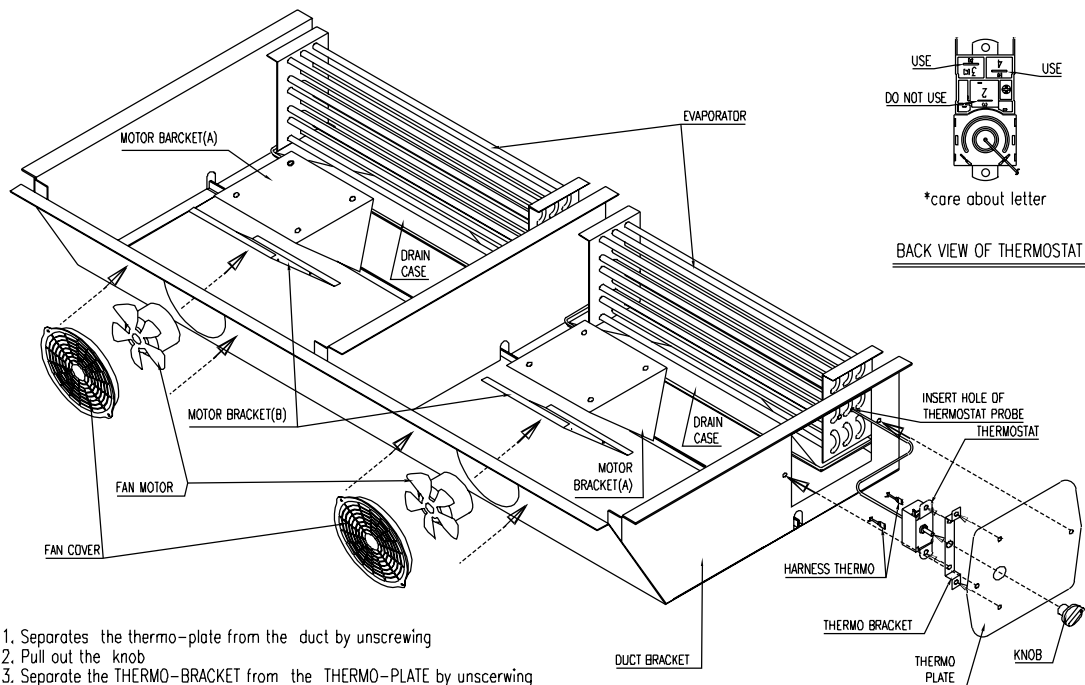

1. Separates the thermo-plate from the duct by unscrewing
2. Pull out the knob
3. Separate the THERMO-BRACKET from the THERMO-PLATE by unscrewing
4. Separate The THERMOSTAT from The THERMO-BRACKET by unscrewing
5. Pull The HARNESS THERMO out of The THERMOSTAT
6. After replacing The THERMOSTAT, Put The BLACK WIRE in "3" TAP and The GRAY WIRE in "4" TAP
7. Insert The THERMOSTAT-PROBE into The INSERT-HOLE at The EVAPORATOR
8. After STEP 7, Assemble above parts from STEP 5 to 1

7. PARTS LIST

Part Name	Part Number	Description	Model									
			69	48	45	35	33	22	14	11	5	
Caster & Leveling Legs												
Castor	30265L0100	1/2" Stem(TP5040-22-HDP-TLE)	2	2	2	2	2	2	2			
Caster	30265L0200	1/2" Stem(TP5040-22-HDP)	2	2	2	2	2	2	2			
Leveling Leg	30260K0100	1/2"	4	4	4	4	4	4				
Leveling Leg	3012101300	BLACK								2	2	
Leveling Leg	4006D32533	BLACK										2
Compressors												
Compressor	30200K2900	AKA4482YXA(TECUMSEH)	1									
Compressor	30200J2100	AEA4448YXA(TECUMSEH)					1					
Compressor	30200A4700	AKA4476YXA(TECUMSEH)		1	1	1						
Compressor	3952127G10	HBL27YE-1(DAEWOO)							1	1	1	
Compressor	3953111E10	HFL11Y-1(DAEWOO)										1
Compressor Relay	3817906900	PTC068							1	1	1	1
Compressor Relay Assembly	30227H0911	Including Harness							1			
Compressor Relay Assembly	30227F0911	Including Harness								1	1	
Compressor Relay Assembly	30200A6411	Including Harness										1
Compressor Overload	3817908600	4TM-783RHB(TEXAS INS.)							1			
Compressor Overload	3817910600	4TM-783SHB(TEXAS INS.)								1	1	
Compressor Overload	3817906500	4TM-293THB(TEXAS INS.)										1
Compressor Running Capacitor	400EL15130	230V 10uF							1	1	1	
Compressor Running Capacitor	401RD35050	220V 100uF							1	1	1	
Condenser	30200K3001	Refer Parts Diagram	1									
Condenser	30200A2201	Refer Parts Diagram		1	1	1	1					
Condenser	30200H1000	Refer Parts Diagram							1			
Condenser	30200F0816	Refer Parts Diagram								1		
Condenser	30200F1110	Refer Parts Diagram									1	
Condenser	30200A7204	Refer Parts Diagram										1
Condenser Fan Motor	3963220410	IS-4420DWSG-1	1	1	1	1	1					
Condenser Fan Motor	3963320410	IS-4420DWSR-1							1			
Condenser Fan Motor	3963226710	IS-3225DWSQ-2								1	1	
Condenser Fan Motor Blade	30218A0100	AL ø 250	1	1	1	1	1					
Condenser Fan Motor Blade	30218B0100	AL ø 225							1			
Condenser Fan Motor Blade	30218F0100	Zytel ø 150								1	1	

PARTS LIST

Part Name	Part Number	Description	Model											
			69	48	45	35	33	22	14	11	5			
Dryer	30268A0100	30g Refer Parts Diagram		1	1	1	1							
Dryer	30268H0100	30g Refer Parts Diagram							1					
Dryer	30268F0403	30g Refer Parts Diagram								1	1			
Dryer	30268K0100	30g Refer Parts Diagram	1											
Dryer	3016801300	10g Refer Parts Diagram												1
Dryer	30268Q0300	C-052-S	1	1		1								
Power Cord	30213A1000	KKP-30B	1	1	1	1	1	1	1	1	1	1	1	1
Power Cord Clamp	30212A0600	SPG	1	1	1	1	1	1	1	1	1	1	1	1
Drain Wicking Pad	30245A0700		1	1	1	1	1							
Drain Pan	30211J0100	HIPS	1	1	1	1	1							
Drain Pan	3021100001	HIPS							1	1	1			
Drain Wicking Bar	30230J0700	PVC-H	1	1	1	1	1							
Doors														
Brush Seal	30277A1301	Bottom		1	1	1	1							
Door Hinge Cap	4009G51041	PE Plastic White												1
Door Assembly *R	30217D0105	Glass, Slide, Right		1										
Door Assembly *L	30217D0206	Glass, Slide, Left		1										
Door Assembly *L	30200J2500	Glass, Slide, Left					1							
Door Assembly *L	30220J2800	Glass, Slide, Left			1									
Door Assembly *R	30200J2400	Glass, Slide, Right					1							
Door Assembly *R	30217A0311	Glass, Slide, Right				1								
Door Assembly *R	30200J2900	Glass, Slide, Right			1									
Door Assembly *L	30217A0301	Glass, Slide, Left				1								
Door Assembly *L	30217K0100	Glass, Slide, Left	1											
Door Assembly *M	30217K0300	Glass, Slide, Middle	1											
Door Assembly *R	30217K0200	Glass, Slide, Right	1											
Door Assembly	30217H0101	Glass, Swing							1					
Door Assembly	30217F0501	Glass, Swing								1				
Door Assembly	30200A8020	Glass, Swing												1
Door Assembly	30217G0301	Glass, Swing											1	
Door Gasket	30222A1001	Wiper Style		1		1								
Door Gasket	30223H0200	Magnetic							1					
Door Gasket	30223F0200	Magnetic								1				
Door Gasket	30223A9006	Magnetic												1
Door Gasket	30223F0100	Magnetic												1

PARTS LIST

Part Name	Part Number	Description	Model											
			69	48	45	35	33	22	14	11	5			
Door Glass	30255K0100	T24	1											
Door Glass	30255J1100	T24					1							
Door Glass	30255J0200	T24			1									
Door Glass	30255D0110	T24		1										
Door Glass	30255A0110	T24				1								
Door Glass	30255H1100	T24						1						
Door Glass	30255F1100	T24							1					
Door Glass	30255A9010	T24												1
Door Glass	30255G1100	T24											1	
Door Handle	30226A0101	Slide ABS Plastic Black	1	1	1	1	1							
Door Handle	30226G0101	Swing Aluminum						1	1	1				
Door Handle	3022600300	Swing Aluminum												1
Door Hinge Bracket Top	30229H3000	Top						1	1	1				
Door Hinge Bracket Top	4004D51301	Top												1
Door Hinge Bracket Bottom	30229H2100	Bottom						1	1	1				
Door Hinge Bracket Bottom	30200B8703	Bottom												1
Door Hinge Bushing	3020700000	Nylon Top						1	1	1				
Door Hinge Bushing	30207H1000	Nylon Bottom						1	1	1				
Door Hinge Bushing	4005B45213	Nylon Top, Bottom												1
Door Hinge Spring	30251H0101	Torsion Style						1						
Door Hinge Spring	30251G0100	Torsion Style							1	1				
Door Hinge Spring	30252H1100	StainlessT1.5 Bottom						1	1	1				
Door Channel Top	30287D0103	PVC-H, Top	1											
Door Channel Top	30287J1100	PVC-H, Top					1							
Door Channel Top	30287A0306	PVC-H, Top			1									
Door Channel Top	30287J1200	PVC-H, Top		1										
Door Channel Bottom	30287D0203	PVC-H, Bottom	1											
Door Channel Bottom	30287J1500	PVC-H, Bottom					1							
Door Channel Bottom	30287A0406	PVC-H, Bottom			1									
Door Channel Bottom	30287J1600	PVC-H, Bottom		1										
Door Channel Left	30287J0500	PVC-H, Left		1		1								
Door Channel Left	30287A0603	PVC-H, Left	1		1									
Door Channel Right	30287J0600	PVC-H, Right		1		1								
Door Channel Right	30287A0703	PVC-H, Right	1		1									
Door Channel Top	30287K0301	PVC-H, Top	1											
Door Channel Bottom	30287K0401	PVC-H, Under	1											

PARTS LIST

Part Name	Part Number	Description	Model																	
			69	48	45	35	33	22	14	11	5									
Door Channel Left	30287K0500	PVC-H, Left	1																	
Door Channel Right	30287K0600	PVC-H, Right	1																	
Door Rail	30287D0300	Stainless		1																
Door Rail	30287A0500	Stainless				1														
Door Rail	30287J2200	Stainless					1													
Door Rail	30287J2100	Stainless			1															
Door Rail (A)	30287K0100	SUS304	1																	
Door Rail (B)	30287K0200	SUS304	1																	
Door Roller	30247A0500				1		1													
Door Roller	30206A1400			1		1														
Door Roller	30206D0300			1		1														
Door Roller	30247K0200	Tok DU-22-H	1																	
Door Sealer Top	30277D0241	Top		1																
Door Sealer Top	30277J0800	Top					1													
Door Sealer Top	30277A0231	Top				1														
Door Sealer Top	30277J0900	Top			1															
Door Stopper	30252H1000	StainlessT3.0 Bottom							1											
Door Stopper	30252F0100	SUS304 T2.0 Bottom								1	1									
Door Stopper Cushion	30252K0200	Rubber Blocks	1																	
Door Stopper Cushion	30252A0200	Rubber Blocks		1		1														
Evaportaors																				
Control Box	30205A9000	HIPS																		1
Evaporator Drain Pan	30211A0101	HIPS		1		1														
Evaporator Drain Pan	30211F0101	HIPS								1										
Evaporator Drain Pan	4017J54111	HIPS																		1
Evaporator Drain Pan	30211K0100	HIPS	1																	
Evaporator Coil	30200J6200	FIN TUBE (AL+Cu)			1		1													
Evaporator Coil	30270K0100	FIN TUBE (AL)	1																	
Evaporator Coil	30270A1100	FIN TUBE(AL+Cu)		1		1														
Evaporator Coil	30270H0100	FIN TUBE(AL)							1											
Evaporator Coil	30270F0104	FIN TUBE(AL+Cu)									1									
Evaporator Coil	30200A8101	ROLL BOND(AL)																		1
Evaporator Coil	30270G0100	AL																	1	
Evaporator Fan Motor	3963329510	IS-3225 DWSL-1-C			2		2													
Evaporator Fan Motor	3963220501	IS-3220DWSF		2		2														

PARTS LIST

Part Name	Part Number	Description	Model																	
			69	48	45	35	33	22	14	11	5									
Evaporator Fan Motor	3963328610	IS-3210DWSB-2						2												
Evaporator Fan Motor	3963328110	IS-4420DWSN-2										1								
Evaporator Fan Motor	3963328120	IS-4420DWSN-2A	2																	
Evaporator Fan Motor	3963328620	IS-3210DWSB-3											1							
Evaporator Fan Motor Blade	30218F0100	Zytel 150			2		2													
Evaporator Fan Motor Blade	4034L38038	Zytel 158		2			2													
Evaporator Fan Motor Blade	3011800400	ABS 110										1			1					
Evaporator Fan Motor Blade	30218F0200	AL 175	2											1						
Evaporator Fixture	30220A9000	PA-6																		1
Evaporator Fan Motor Guard	30214H0102	ABS											1							
Evaporator Fan Motor Guard	30214K0100	HIPS	1																	
Lamp Switch	30281A0600	125V/6A	1	1	1	1	1	1	1	1	1	1	1	1	1	1	1	1	1	1
Thermometer	30283G0410	MILJOCO	1	1	1	1	1	1	1	1	1	1	1	1	1	1	1	1	1	1
Thermostat	30283K0100	K55-Q5605(Ranco)		1																
Thermostat	30283K0110	K55-Q5606(Ranco)	1																	
Thermostat	30283D0700	K55-Q5602(Ranco)			1		1		1		1									
Thermostat	30283D0800	K61-Q5603(Ranco)													1		1			
Thermostat	3018301001	PFN-110U-02D, GNF-110U-02D																		1
Thermostat Bracket	30220A1410	SPG, Refer Parts Diagram											1				1			
Thermostat Bracket	30206F1000	SPG, Refer Parts Diagram															1			
Thermostat Bracket	30220J1000	SPG, Refer Parts Diagram			1		1		1		1									
Thermostat Knob	30234A1000	HIPS	1	1	1	1	1	1	1	1	1	1	1	1	1	1	1	1	1	1
Thermostat Knob	4006D70026	HIPS OFF1234567																		1
Thermostat Plate	30242J0100	EGI+Painting				1				1										
Thermostat Plate	30206A0200	EGI+Painting		1						1										
Thermostat Plate	30206H0104	EGI+Painting											1							
Thermostat Plate	30242F0802	HIPS																	1	
Thermostat Plate	30245K0100	EGI 0.6	1																	
Grills																				
Bottom Grill Assembly	30200D5500	Ass'y Front Painted		1																
Bottom Grill Assembly	30200A5500	Ass'y Front Painted									1									
Bottom Grill Assembly	30224H0100	Front ABS Dark Gray												1						
Bottom Grill Assembly	30200J2300	Ass'y Front Painted												1						
Bottom Grill Assembly	30200J4300	Ass'y Front Painted			1															

PARTS LIST

Part Name	Part Number	Description	Model																		
			69	48	45	35	33	22	14	11	5										
Bottom Grill Assembly	30224F0102	Front ABS Dark Gray									1	1									
Bottom Grill Assembly	30224K0100	Ass'y Grill	1																		
Lightings																					
Ballast	30285D0500	32Watt x 1 R-2P32-TP	2	1																	
Ballast	30285A0700	32Watt x 1 R-1P32-TP			1	1	1														
Ballast	30200A0110	25Watt x 1 R-1P825-TP				1															
Ballast	30285J1200	25Watt x 2 R-2P825-TP		1																	
Ballast	30285H1500	17Watt x 2 R-2P817-TP						1	1												
Ballast	30200A0140	13Watt x 1 DD22B																			1
Lamp	30200D2800	32Watt F32T8/TL85048"	4	2	1	1	1														
Lamp	30236A0500	25Watt F25T8/TL95036"			1	1															
Lamp	30236H0500	17Watt F17T8/TL95024"						1	2												
Lamp	30236F0500	13Watt F13T8/CW12"										2	1	1							
Lamp Shield	30214F0701	ACRYL																		1	
Lamp Shield	30214A0010	ACRYL																			1
Lamp Holder	3183005000	SK-5OD28		2		2		2	2												
Lamp Shield	3021101101	PC, t0.5	2	1	1	1															
Lamp Shield	30211H0000	PC, t0.5							1												
Lamp Shield	30211F0000	PC, t0.5										1									
Light Starter	30236A0700	FS-2																			1
Lamp Switch	30281A0600	125V/6A	1	1	1	1	1	1	1	1	1	1	1	1	1	1	1	1	1	1	1
Shelves																					
Shelf	30278D0107	Wire, White		6																	
Shelf	30278A0207	Wire, White				6															
Shelf	30278K0100	Wire, White	9																		
Shelf	30278H0103	Wire, White							4												
Shelf(A)	30278F0111	Wire, White TOP										3									
Shelf(B)	30278F0211	Wire, White BOTTOM										1									
Shelf(T)	30278A9401	Wire, White TOP																			1
Shelf *L	30278J0100	Wire, White							3												
Shelf *L	30278J0300	Wire, White			3																
Shelf *R	30278J0200	Wire, White								3											
Shelf *R	30278J0400	Wire, White			3																

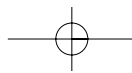

PARTS LIST

Part Name	Part Number	Description	Model																	
			69	48	45	35	33	22	14	11	5									
Shelf(M)	30278A9150	Wire, White MIDDLE																		1
Shelf(B)	30278A9000	Wire, White BOTTOM																		1
Shelf(A)	30278G0111	Wire, White TOM																		3
Shelf(B)	30278G0401	Wire, White BOTTOM																		1
Shelf Bracket	30220A0200	Front Center White	2	1		1														
Shelf Clip(E)	30220A0700	PP TOP	36	24		24														
Shelf Clip(D)	30220A0600	Nylon BOTTOM	36	24		24														
Shelf Standard	3022000703	Sides & Back of Cabinet White	4	4		4														
Shelf Support	30253A0500	Back Center White	2	1		1														
Sign Frame																				
Sign Frame *T*B	30222K0900	PVC-H	1																	
Sign Frame *T*B	30222D0500	PVC-H		1																
Sign Frame *T*B	30222A0800	PVC-H				1														
Sign Frame End	30222A0900	PVC-H	1	1		1														
Sign Frame *T*B	30222H0310	PVC-H																		1
Sign Frame *T*B	30222F1902	PVC-H																		1
Sign Frame End	30222F2103	ABS Dark Gray																		1
Sign Frame End *L	30222J0100	PVC-H				1														1
Sign Frame End *R	30222J0200	PVC-H				1														1
Sign Frame Bracket	30220A0900	Aluminum	1	1		1														
Sign Panel	30214D0710	PC, t1.5		1																
Sign Panel	30214A1211	PC, t1.5				1														
Sign Panel	30214H0110	PC, t3.0																		1
Sign Panel	30214F0110	PC, t3.0																		1
Sign Panel	30214J4500	PC, t1.5																		1
Sign Panel	30214J4600	PC, t1.5				1														
Sign Panel	30214K1400	PC, t1.5	1																	

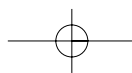

PARTS LIST

Part Name	Part Number	Description	Model				
			11RV	14RV	14CRV	22RV	22CRV
Lightings							
Ballast	30200F7300	25Watt x R-1P825TP		1	1		
Ballast	30200G7300	25Watt x R-1P825TP	1				
Ballast	30200A0141	13Watt x 1DD22B		1	1		
Ballast	30200H7400	17Watt x R-1P817-TP				1	1
Ballast	30200H7300	32Watt x R-1P32-TP				1	1
Lamp	30236A0500	25Watt F25T8/TL95036"	1	1	1		
Lamp	30236F0500	13Watt F13T8' CW12"		1	1		
Lamp	30236H0500	17Watt F17T8/TL95024"				1	1
Lamp	30200D0500	32Watt F32TB/TL85048"				1	1
Lamp Shield	30211K0200	PC, T0.5				1	1
Lamp Shield	30211F0400	PC, T0.5	1	1	1		
Shelves							
Shelf(A)	30278G0700	Wire, White, Top	3				
Shelf(B)	30278G0401	Wire, White, Bottom	1				
Shelf(A)	30278F0300	Wire, White, Top		3	3		
Shelf(B)	30278F0211	Wire, White, Bottom		1	1		
Shelf	30278H0400	Wire, White				4	4

** Other parts are the same parts as TGM-11R, TGM-14R, TGM-22R

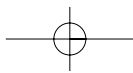

8. REPLACEMENT OF MAIN COMPONENTS

1. LAMP FOR ADVERTISING PANEL(TGM-69R, 48R, 45R, 35R, 33R)



1. Separate the Sign Frame End.



2. Separate the Sign Panel.



3. Separate the Lamp Socket.



4. Separate the Lamp out of the Lamp Holder and replace it.

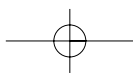

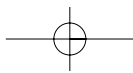

REPLACEMENT OF MAIN COMPONENTS

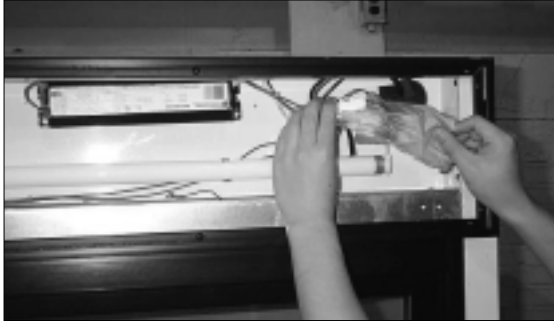

5. Take out the Clamp securing wires.



6. Separate the Ballast Connectors.

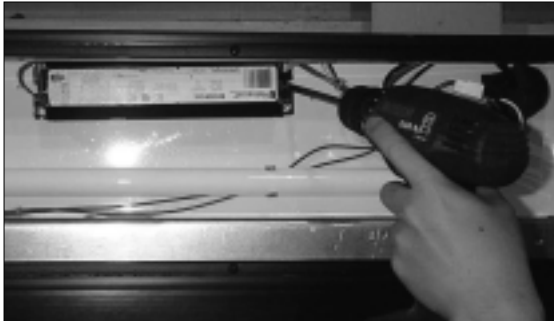

7. Unscrew two screws securing the Ballast and replace it.

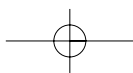

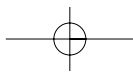

REPLACEMENT OF MAIN COMPONENTS

1. LAMP FOR CABINET LINER(TGM-69R, 48R, 45R, 35R, 33R)



1. Take out the Doors and separate the Lamp from the Lamp Holder.

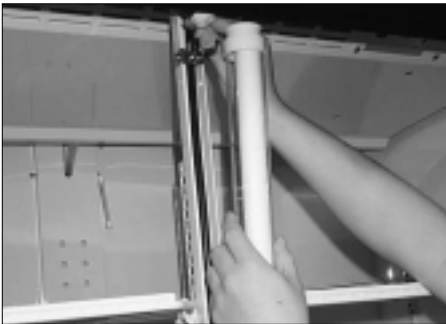

2. Separate the Lamp Socket.

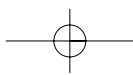

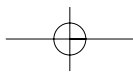

REPLACEMENT OF MAIN COMPONENTS



3. Separate the Lamp Shield End Cap.



4. Replace the Lamp.

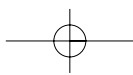

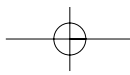

REPLACEMENT OF MAIN COMPONENTS

1. LAMP(TGM-22R,14R)



1. Unscrew four screws securing the Sign Frame End and separate the Sign Frame End.



2. Separate the Sign Panel.



3. Separate the Lamp Sockets and replace the Lamp.

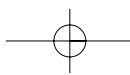

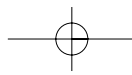

REPLACEMENT OF MAIN COMPONENTS



4. Separate connector of the ballast.



5. Unscrew two screws securing the Ballast.



6. Separate the Lamp Sockets to replace the Lamp for Cabinet Liner.



7. Separate the Lamp Shield End Cap and replace the Lamp.

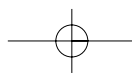

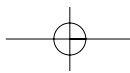

REPLACEMENT OF MAIN COMPONENTS

1. LAMP BASE ASSEMBLY FOR VERTICAL LAMP SERIES



TGM-11RV



TGM-14RV, TGM-22RV

1. UNSCREW THE SCREWS OF THE HOUSING COVER

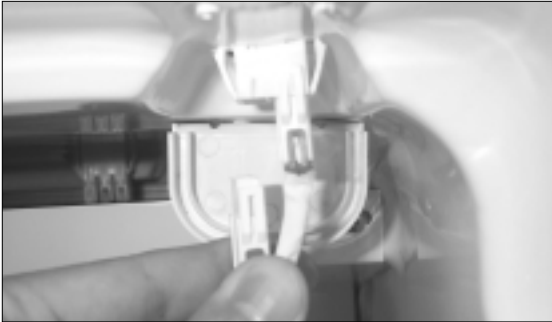

TGM-11RV



TGM-14RV, TGM-22RV

2. PULL OUT THE HOUSING

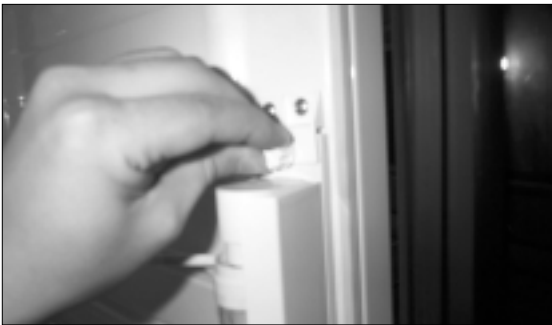

3. UNSCREW THE SPECIAL BOLT THAT IS FIXING THE LAMP BASE ASSEMBLY (3POINTS)

4. PULL OUT THE LAMP BASE ASSEMBLY

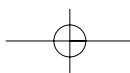

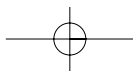

REPLACEMENT OF MAIN COMPONENTS

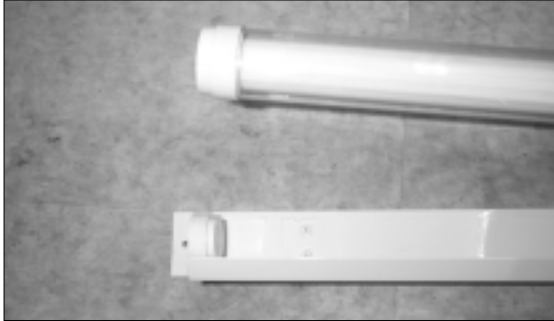

5. SEPARATE THE FLUORESCENT LAMP FROM THE LAMP HOLDER



6. PULL OUT THE LAMP CAP FROM THE LAMP CASE



7. REPLACE THE FLUORESCENT LAMP AFTER PULL OUT THE FLUORESCENT LAMP FROM THE LAMP CASE.

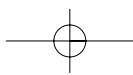

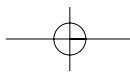

REPLACEMENT OF MAIN COMPONENTS

1. LAMP(TGM-11R,5R)



1. Unscrew two screws securing the Lamp Shield.



2. Disassemble the Lamp Shield.



3. Separate the Lamp out of the Lamp Holder and replace it.

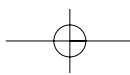

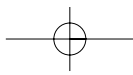

REPLACEMENT OF MAIN COMPONENTS

2. TEMPERATURE CONTROL AND LIGHT SWITCH(TGM-69R, 48R, 45R, 35R, 33R)

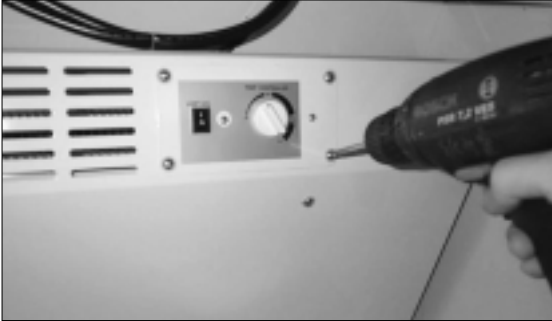

1. Unscrew four screws securing the Thermostat control plate.

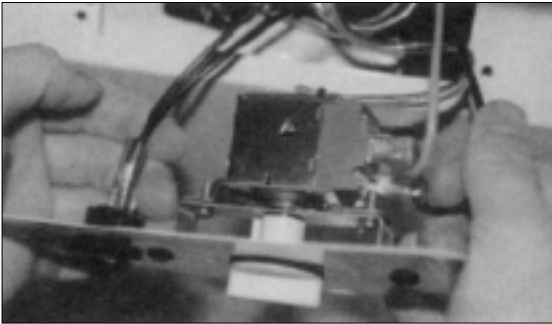

2. Pull out the Thermostat control plate.



3. Separate the Receptacles out of the Thermostat and Lamp Switch.

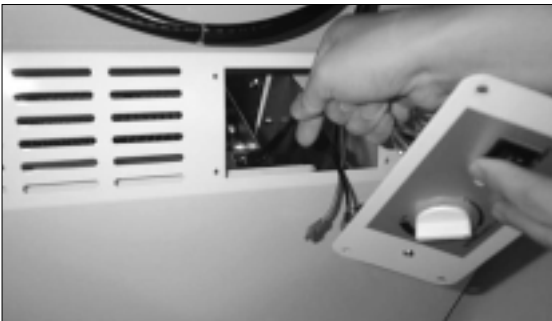

4. Separate the Tube of Thermostat from the Evaporator.

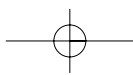

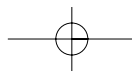

REPLACEMENT OF MAIN COMPONENTS



5. Separate the Thermostat Knob out of the Thermostat.

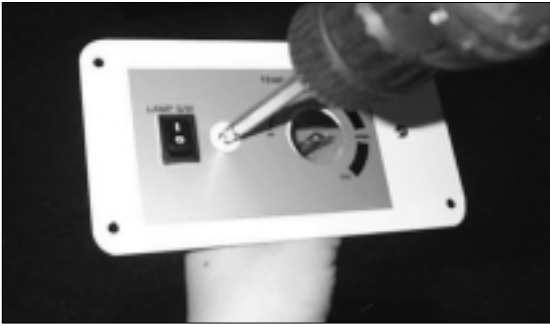

6. Unscrew two screws securing the Thermostat.

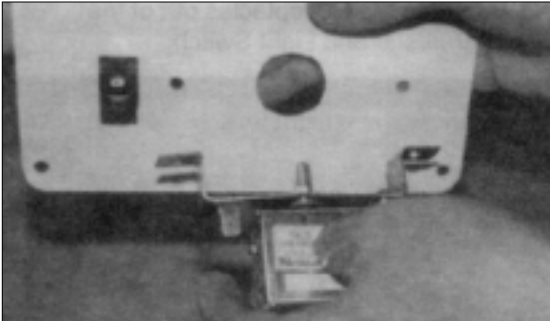

7. Separate the Thermostat out of the Thermostat plate.

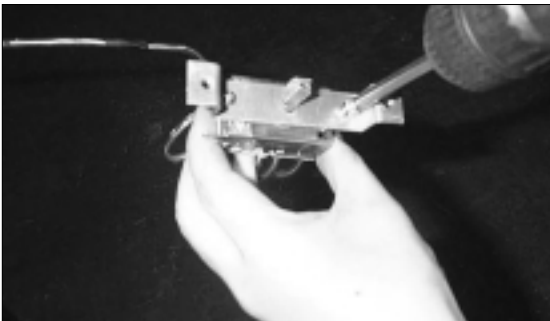

8. Unscrew two screws securing the Thermostat out of the Thermostat Bracket.

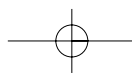

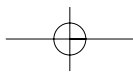

REPLACEMENT OF MAIN COMPONENTS

2. THERMOSTAT CONTROL AND LIGHT SWITCH (TGM-14R, 14RV)



1. Unscrew two screws securing the Thermostat Plate.



2. Pull out the Thermostat Plate.



3. Separate the Receptacles out of the Thermostat and Light Switch.

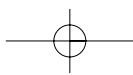

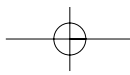

REPLACEMENT OF MAIN COMPONENTS



4. Separate the Tube of Thermostat from the Evaporator.



5. Separate the Thermostat out of the Thermostat Plate.

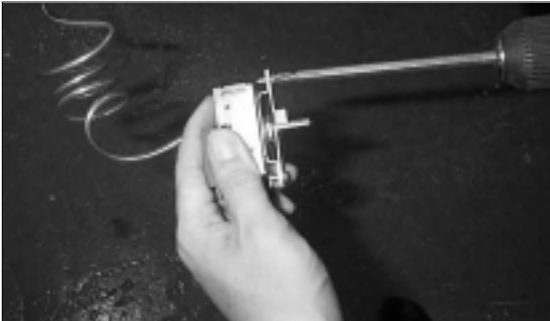

6. Unscrew two screws securing the Thermostat out of the Thermostat Bracket.

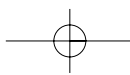

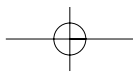

REPLACEMENT OF MAIN COMPONENTS

2. TEMPERATURE CONTROL AND LIGHT SWITCH(TGM-11R, 11RV)



1. Unscrew six screws securing the Duct.



2. Unscrew four screws securing the Thermostat Plate.



3. Separate the Receptacles out of the Thermostat and Lamp Switch.

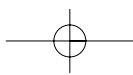

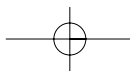

REPLACEMENT OF MAIN COMPONENTS

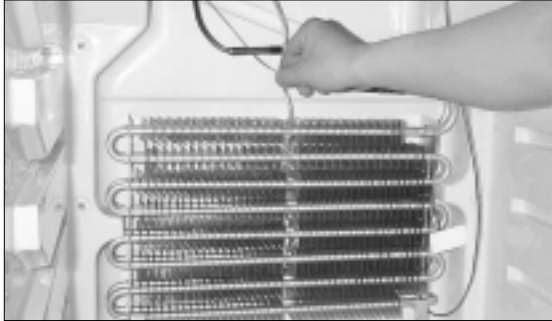

4. Separate the Tube of Thermostat from the Evaporator Coil.

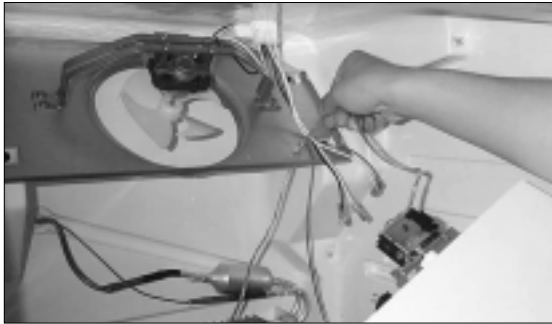

5. Pull out the Thermostat plate.



6. Separate the Thermostat out of the Thermostat plate.

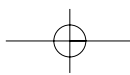

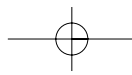

REPLACEMENT OF MAIN COMPONENTS

2. TEMPERTURE CONTROL AND LIGHT SWITCH(TGM-5R)



1. Unscrew two screws securing the Control Box.



2. Separate the Connectors.



3. Unscrew two screws securing the Tube of Thermostat out of the Thermostat Fixture.

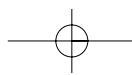

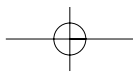

REPLACEMENT OF MAIN COMPONENTS

3. EVAPORATOR FAN MOTOR & BLADE(TGM-69R, 48R, 45R, 35R, 33R)



1. Unscrew four screws securing the Thermostat Plate.

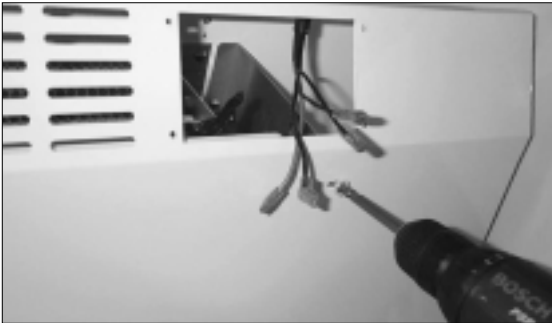

2. Unscrew eight screws securing the Duct.

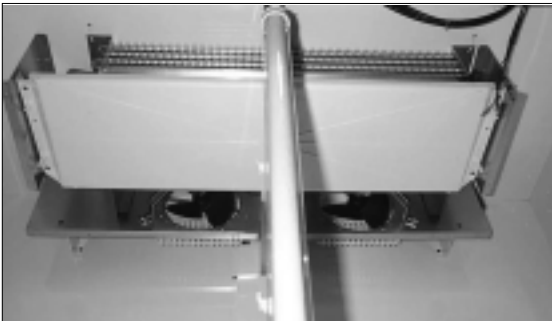

3. Separate the Duct.



4. Unscrew four screws securing the Evaporator Drain Pan.

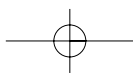

REPLACEMENT OF MAIN COMPONENTS

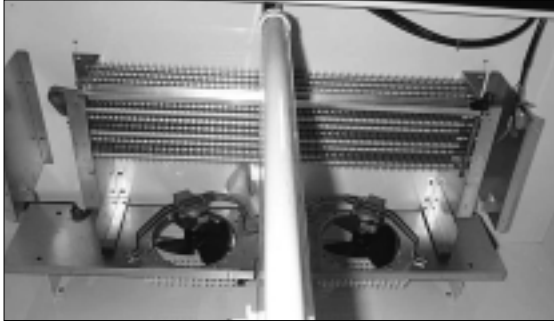

5. Separate the Evaporator Drain Pan.



6. Unscrew four screws securing the Evaporator Guide *L, *R and separate them.

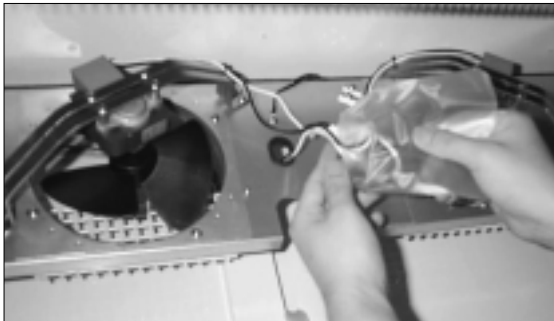

7. Separate the Vinyl Cover securing the Evaporator Fan Motor.

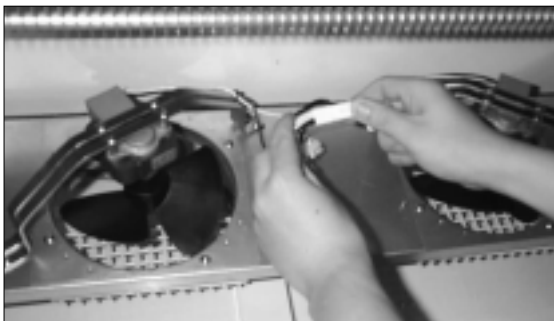

8. Separate the Connectors of Evaporator Fan Motor.

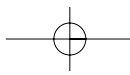

REPLACEMENT OF MAIN COMPONENTS

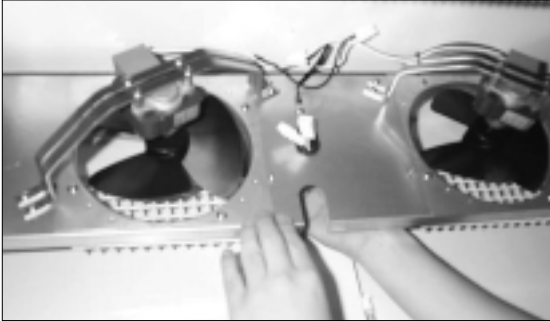

9. Pull out of the Evaporator Fan Motor Harness.

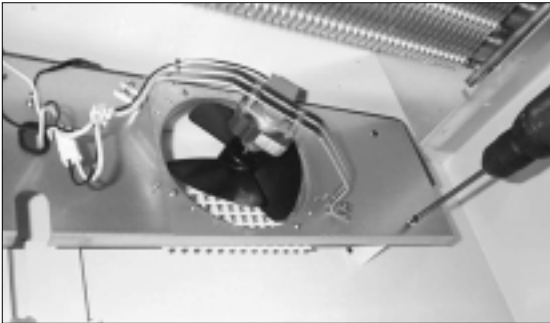

10. Unscrew two screws securing the Evaporator Fan Motor Bracket.



11. Separate the Evaporator Fan Motor Bracket.

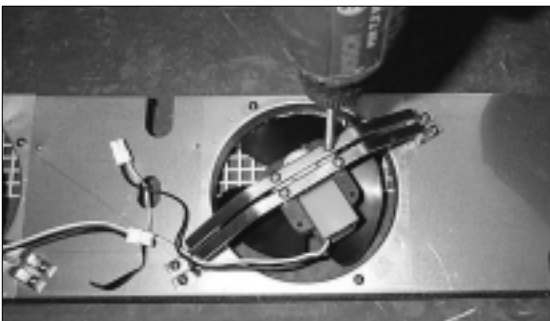

12. Unscrew four screws securing the Evaporator Fan Motor out of the Bracket.

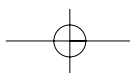

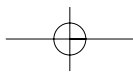

REPLACEMENT OF MAIN COMPONENTS

3. EVAPORATOR FAN MOTOR & BLADE(TGM-22R, 22RV)



1. Unscrew the screw securing the Evaporator Fan Motor Guard.



2. Separate the Evaporator Fan Motor Cover.

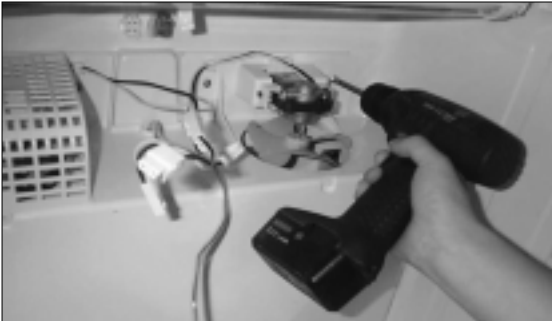

3. Replace the Evaporator Fan Motor.

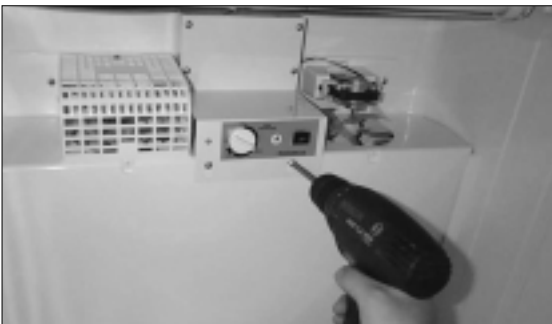

4. Unscrew four screws securing the Thermostat Plate.

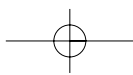

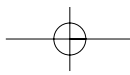

REPLACEMENT OF MAIN COMPONENTS

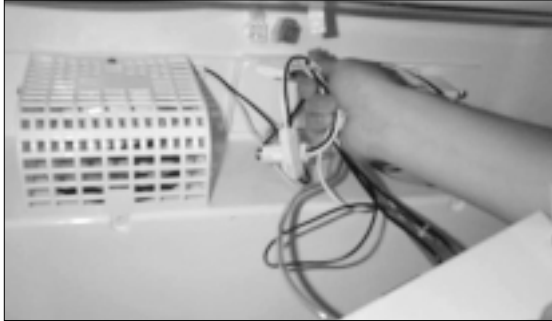

5. Separate the Thermostat Plate.
Pull out the tube of Thermostat out of the Evaporator Coil.

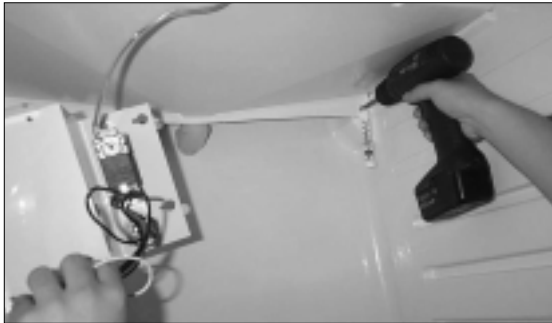

6. Unscrew four screws securing the Duct.



7. Separate the Duct.

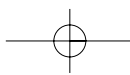



REPLACEMENT OF MAIN COMPONENTS

3. EVAPORATOR FAN MOTOR & BLADE(TGM-14R, 14RV)



1. Unscrew the screws securing the Thermostat Plate and two screws securing the Duct.



2. Separate the Duct.
(**Caution:** Pulling the Duct in to the front can cause the Fan Blade to be bent.)



3. Unscrew four securing the Evaporator Fan Motor Bracket.

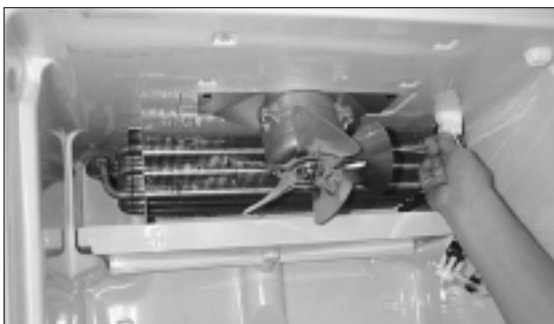

4. Separate the Connectors of Fan Motor, the Nut and replace the Fan Blade.



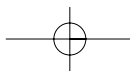

REPLACEMENT OF MAIN COMPONENTS



5. Unscrew two screws securing the Evaporator in case of replacing it.

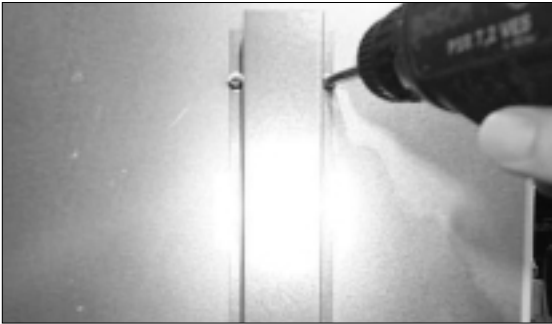

6. Separate Suction Pipe Cover on the Rear Cabinet.

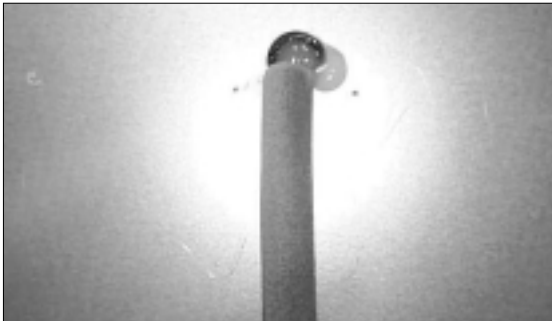

7. Separate the Sealing Tube.

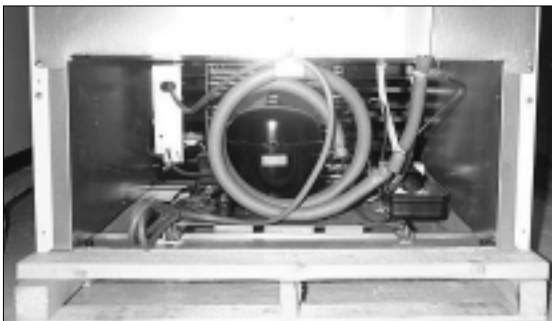

8. Replace the Suction Pipe with welding machine.

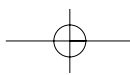

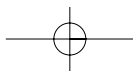

REPLACEMENT OF MAIN COMPONENTS



9. Pull out the Evaporator Coil.
(**Caution:** Pulling the Evaporator can cause the Cabinet Liner to be scratched.)



10. Separate the Evaporator Coil out of the Evaporator Drain Pan and repair the Evaporator Coil.

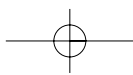

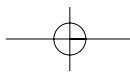

REPLACEMENT OF MAIN COMPONENTS

3. EVAPORATOR FAN MOTOR & BLADE(TGM-11R, 11RV)



1. Unscrew the screws securing the Duct.



2. Unscrew the screws securing the Thermostat Plate.



3. Separate the harness out of the Thermostat and Lamp Switch.

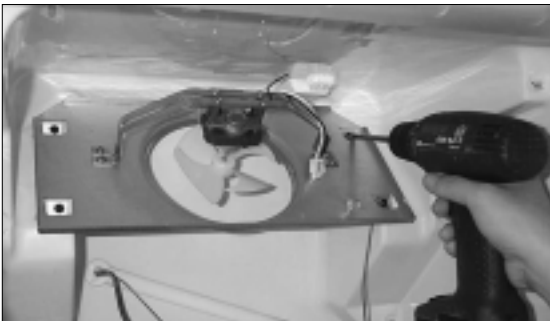

4. Separate the Evaporator Fan Motor Bracket.

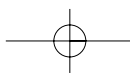

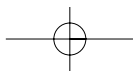

REPLACEMENT OF MAIN COMPONENTS

4. CONDENSER FAN MOTOR & BLADE(TGM-69R, 48R, 45R, 35R, 33R)



1. Unscrew four screws securing the Bottom Grill.



2. Separate the Compressor Harness out of the Switch Box.



3. Unscrew four screws securing the Compressor Base.



4. Pull the Compressor Base and separate the Condenser Fan Motor.

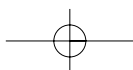

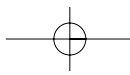

REPLACEMENT OF MAIN COMPONENTS

4. CONDENSER FAN MOTOR & BLADE(TGM-22R, 22RV)

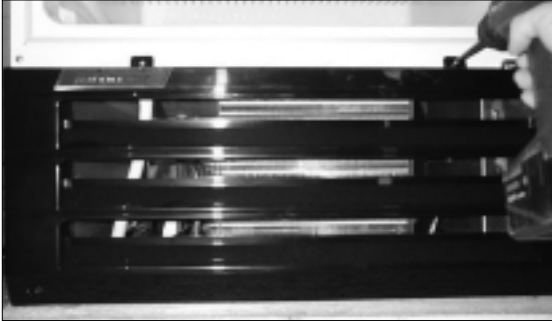

1. Unscrew four screws securing the Bottom Grill.

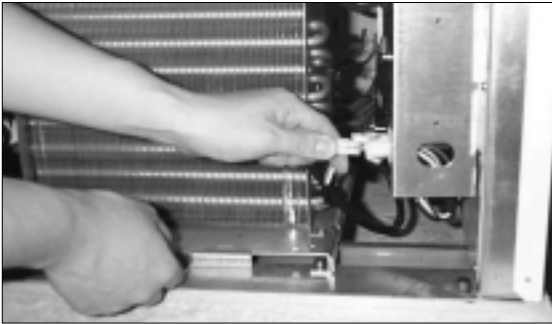

2. Separate the Connector out of the Switch Box.

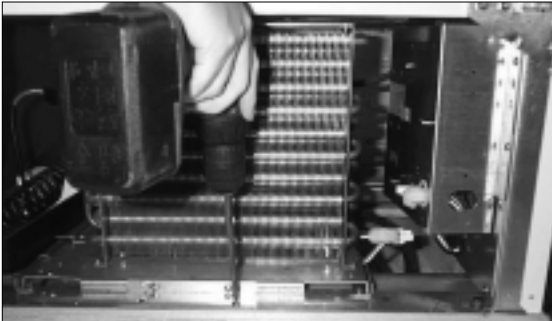

3. Unscrew four screws securing the Compressor Base.

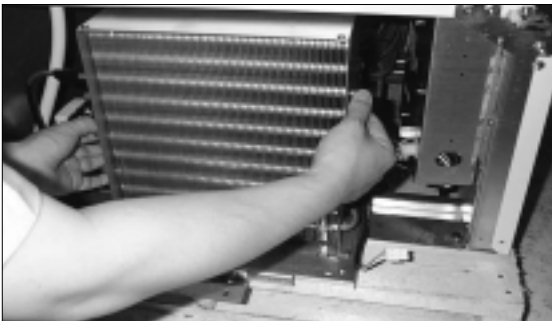

4. Pull the Compressor Base and separate the Condenser Fan Motor.

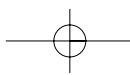

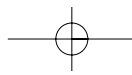

REPLACEMENT OF MAIN COMPONENTS

4. CONDENSER FAN MOTOR & BLADE(TGM-14R, 14RV, 11R, 11RV)



1. Unscrew four screws securing the Bottom Grill.

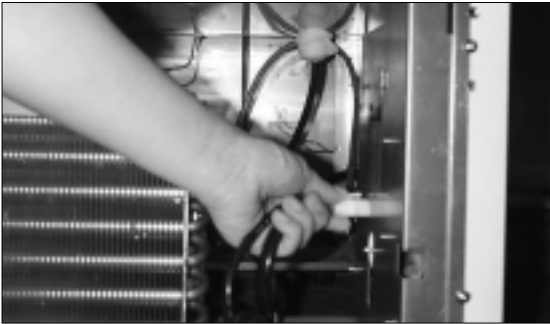

2. Separate the Connector out of the Switch Box.

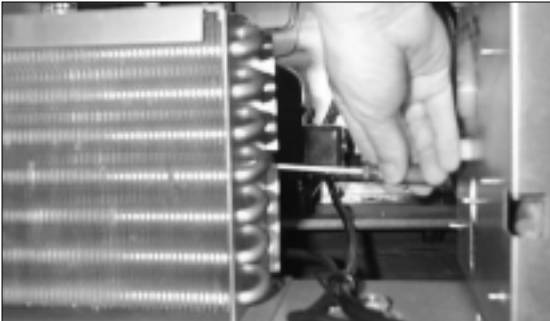

3. Unscrew four screws securing the Condenser Fan Motor Bracket.



4. Pull the Condenser Fan Motor with care.

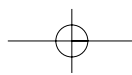

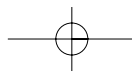

REPLACEMENT OF MAIN COMPONENTS



5. Separate the Fan Motor Bracket.

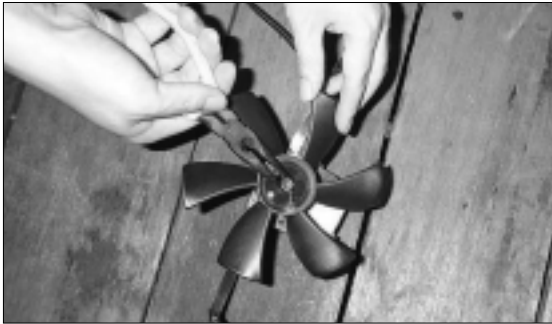

6. Separate the nut and replace the Fan Blade.

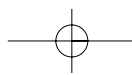

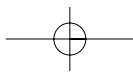

REPLACEMENT OF MAIN COMPONENTS

5. DOOR(TGM-22R, 22RV, 14R, 14RV)



1. Separate the Sign Frame End and Sign Panel.



2. Separate the Door Hinge Top and Door.

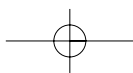
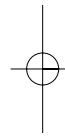
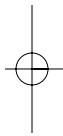

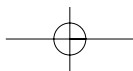

Turbo air REFRIGERATOR MANUFACTURER

Commercial Freezer Service Manual

Model No.: TGF-49F
TGF-23F
TGF-13F
TGF-9F

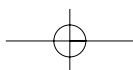
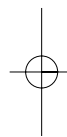
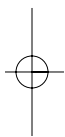

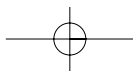

1. FEATURE CHART

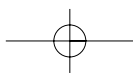
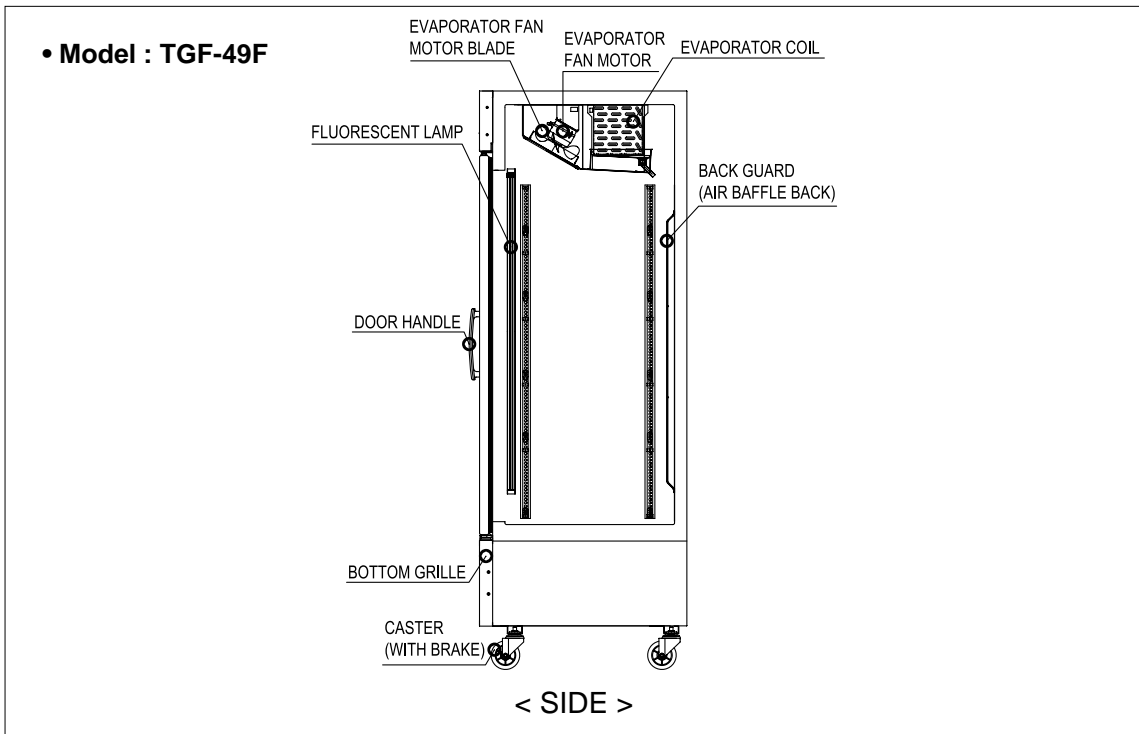
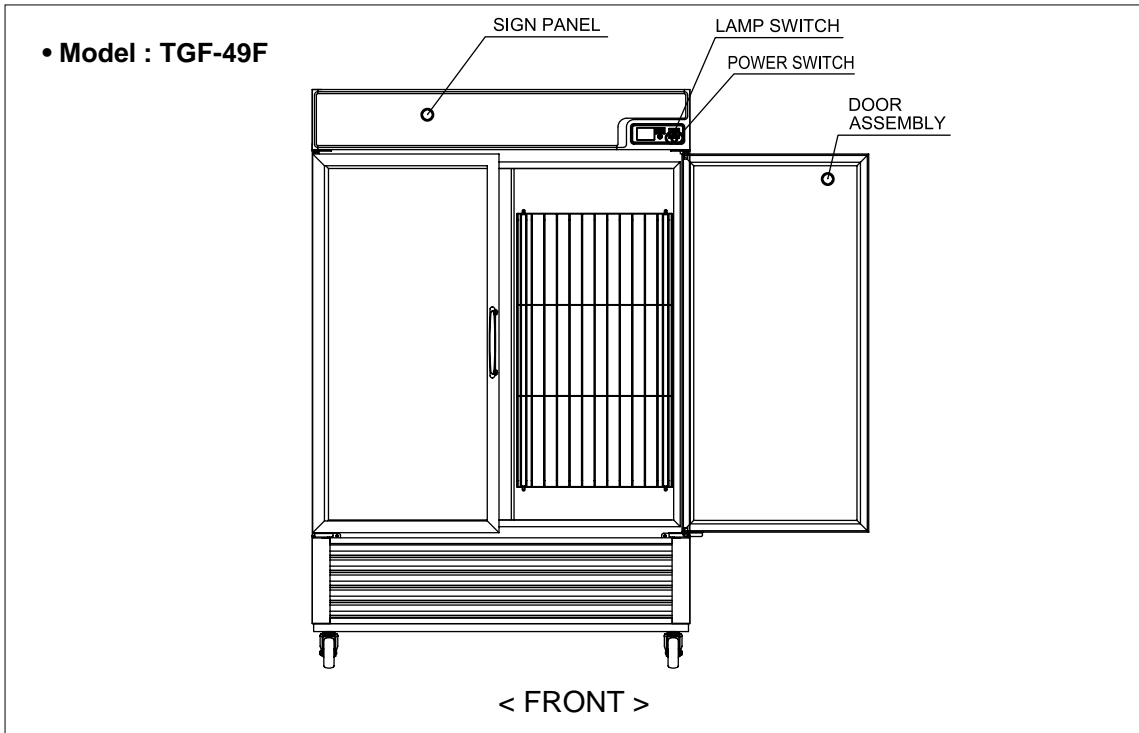

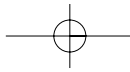

FEATURE CHART

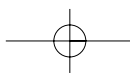
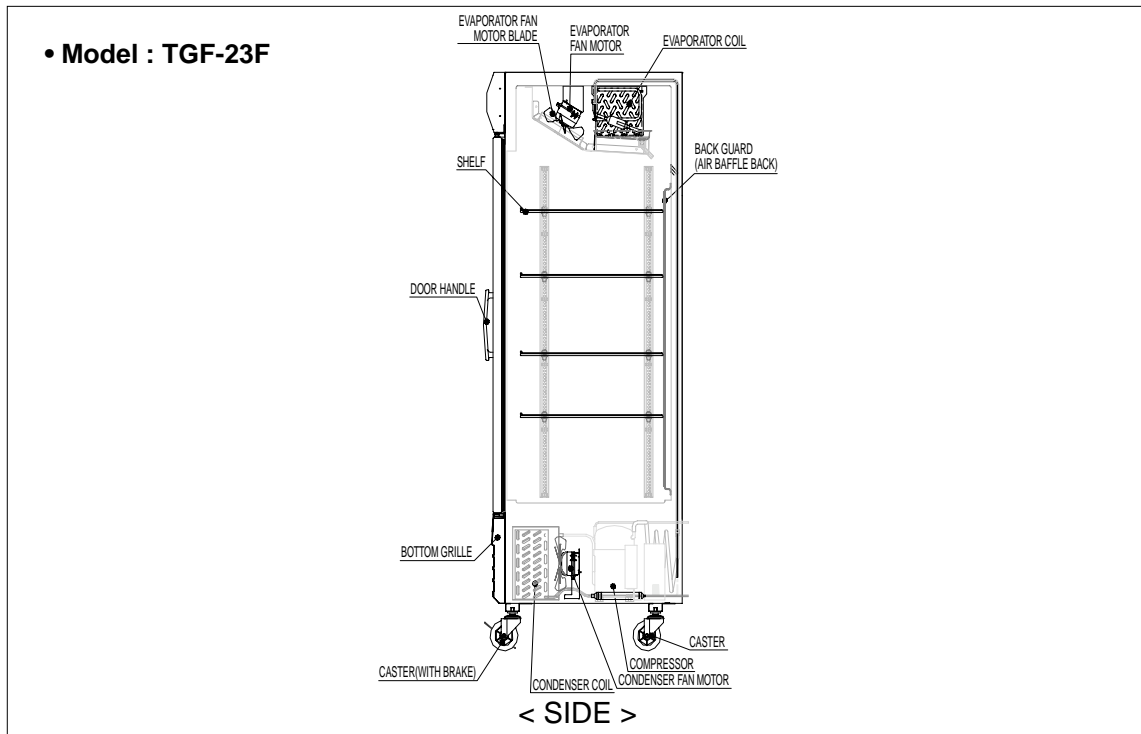
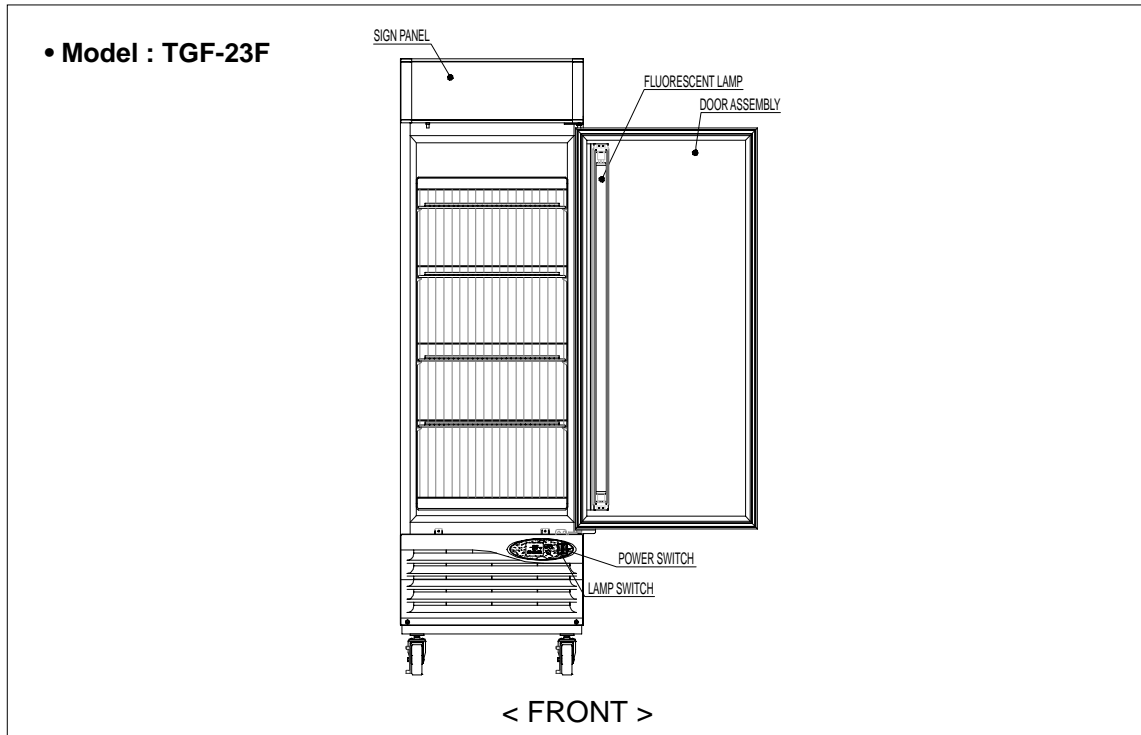

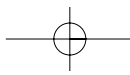

FEATURE CHART

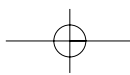
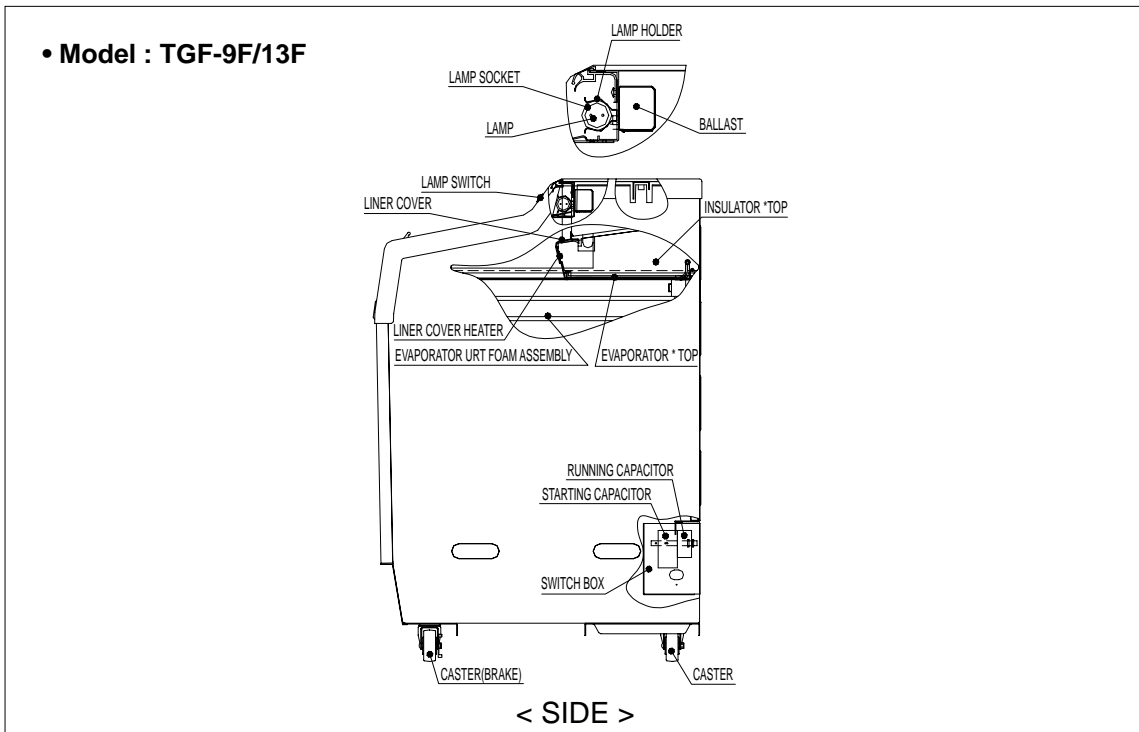
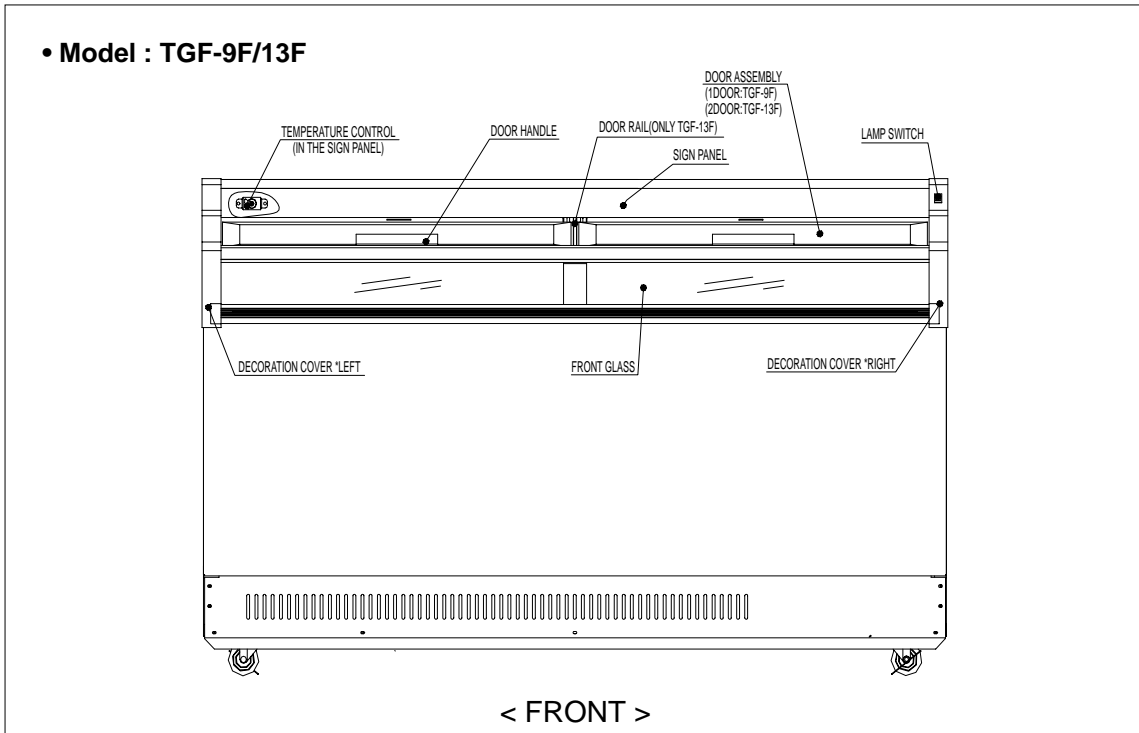

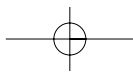

FEATURE CHART

• Model : TGF-9F/13F

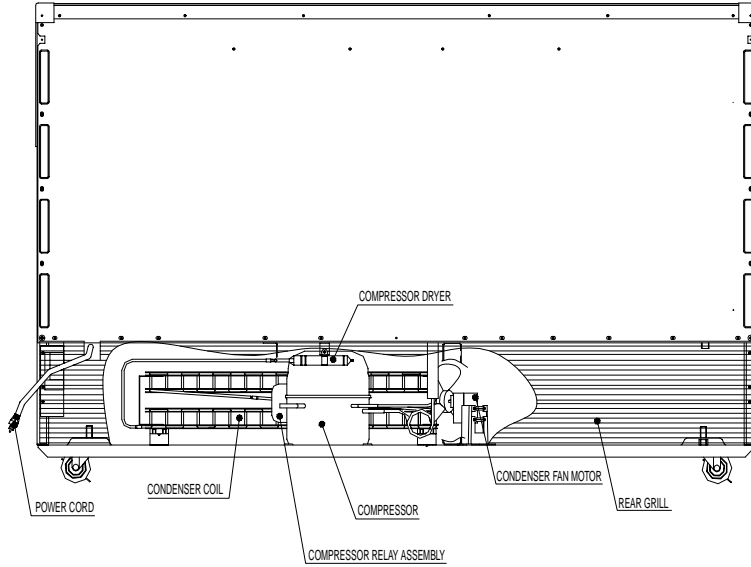

< BACK >

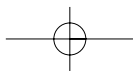

2. PARTS DETAILS

DOOR PARTS : TGF-23F

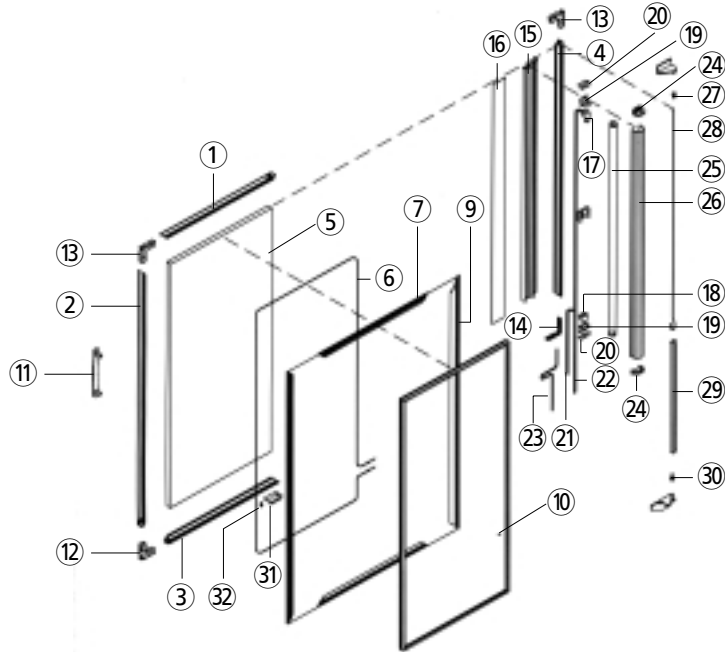

- | | | | |
|----|--------------------------------------|----|---------------------------------|
| 1 | DOOR FRAME *TOP | 18 | LAMP SOCKET
(WITHOUT SPRING) |
| 2 | DOOR FRAME *LEFT | 19 | LAMP SOCKET BRACKET |
| 3 | DOOR FRAME *BOTTOM | 20 | LAMP SHIELD FIXTURE |
| 4 | DOOR FRAME *RIGHT | 21 | LAMP SOCKET HARNESS-A |
| 5 | DOOR GLASS | 22 | LAMP SOCKET HARNESS-B |
| 6 | DOOR FRAME HEATER | 23 | DOOR HEATER HARNESS |
| 7 | AUXILIARY DOOR FRAME *TOP
*BOTTOM | 24 | LAMP SHIELD CAP |
| 8 | AUXILIARY DOOR FRAME *LEFT
*RIGHT | 25 | LAMP |
| 9 | AUXILIARY DOOR FRAME -A | 26 | LAMP SHIELD |
| 10 | DOOR GASKET | 27 | DOOR BUSHING *TOP |
| 11 | DOOR HANDLE | 28 | BAR SPRING |
| 12 | DOOR FRAME FIXTURE-A | 29 | BAR SPRING FIXTURE |
| 13 | DOOR FRAME FIXTURE-B | 30 | DOOR BUSHING *BOTTOM |
| 14 | DOOR FRAME FIXTURE-D | 31 | DOOR STOPPER-A |
| 15 | LAMP MOUNTING BASE | 32 | CORD BUSHING |
| 16 | DOOR SIGN PANEL | | |
| 17 | LAMP SOCKET
(WITH SPRING) | | |

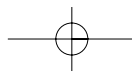

PART DETAILS

Duct (TGF-23F)

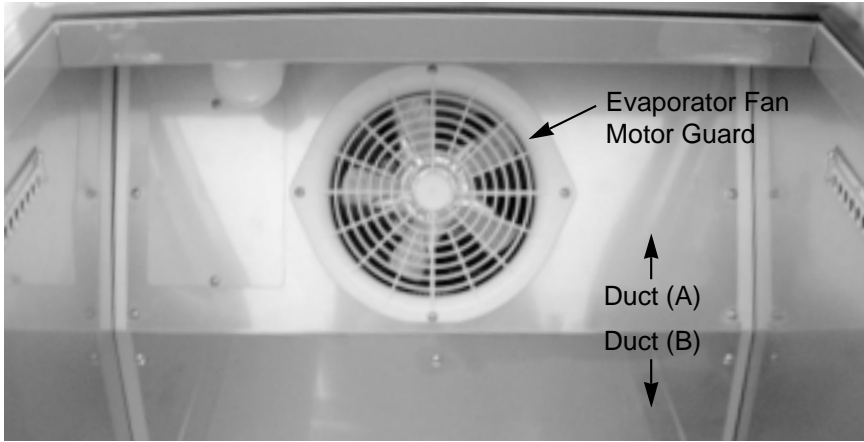

Evaporator, Fan (TGF-23F)

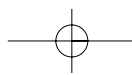
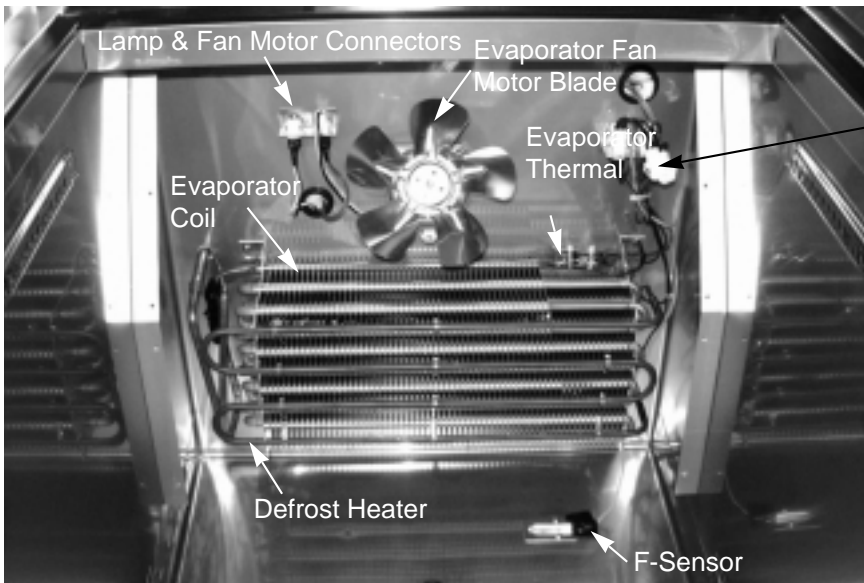

3. WIRING DIAGRAM

• Model : TGF-49F

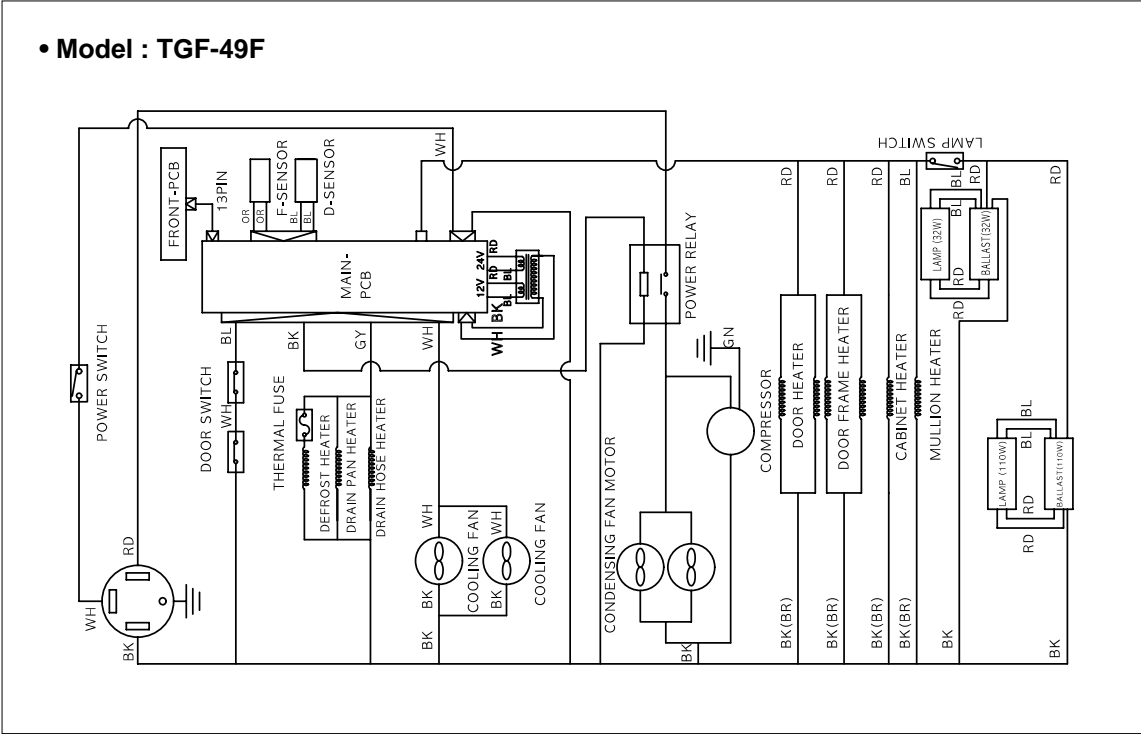

• Model : TGF-23F

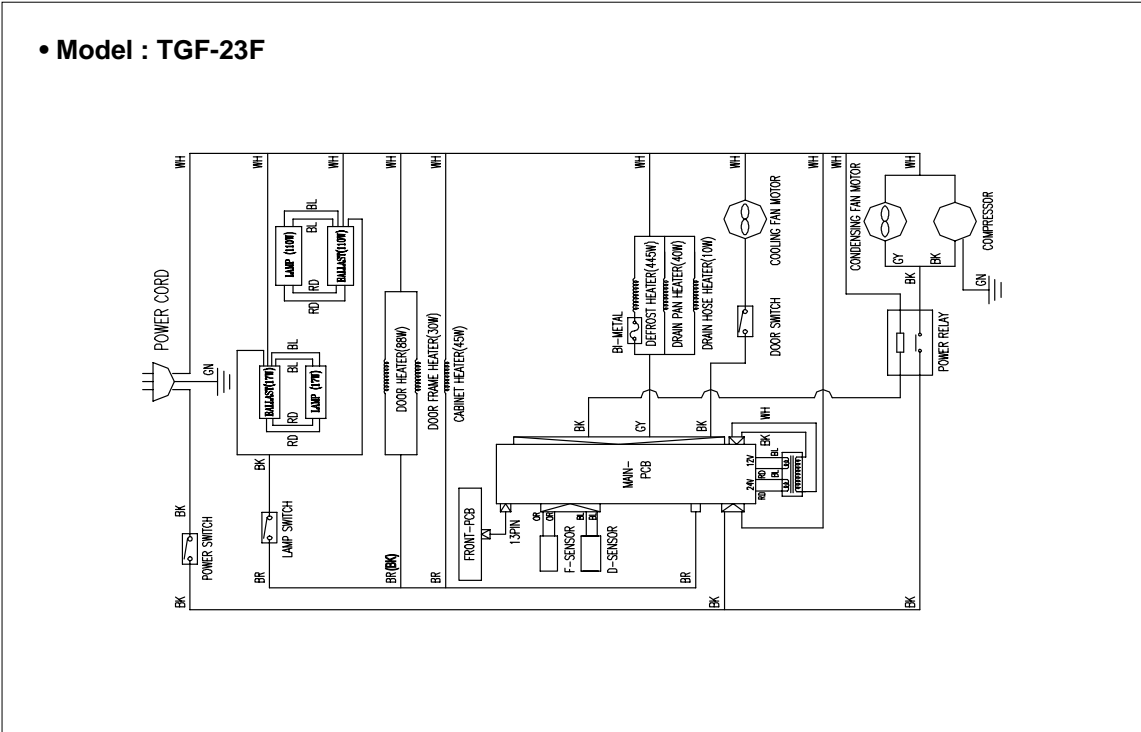

4. SPECIFICATION OF MAIN COMPONENTS

1. COMPRESSOR

MODEL	PART NAME	PART NO.	HORSE POWER	CAPACITY	TYPE OF MOTOR	INPUT	MAKER
TGF-49F	CAJ2464Z	30200R1900	3/2 HP	6,452 BTU/h (1,626 Kcal/h)	CSR	1,232W	TECUMSEH (FRANCE)
TGF-23F	CAJ2432Z	30200R1000	2/3 HP	3,200 BTU/h (807 Kcal/h)	CSR	810W	TECUMSEH (FRANCE)
TGF-13F	AEZ2415Z	30200N4400	1/3 HP	1,459 BTU/h (368 Kcal/h)	CSIR	280W	TECUMSEH (FRANCE)
TGF-9F	HBL27YE-1	3952127G10	1/4 HP	896 BTU/h (226 Kcal/h)	CSR	220W	DAEWOO

2. COMPRESSOR RELAY, OVERLOAD

MODEL	RELAY	PART NO.	OVERLOAD	PART No.	MAKER	NOTE
TGF-49F	3ARR3*3A*	-	GA3SJU81	-	TECUMSEH(FRANCE)	Comp. Assembly
TGF-23F	3ARR3*5R*	-	CST00AGF	-	TECUMSEH(FRANCE)	Comp. Assembly
TGF-13F	3ARR12KP(+)+479	-	MRP24AIK	-	TECUMSEH(FRANCE)	Comp. Assembly
TGF-9F	PTC 068	3017906900	4TM-783SHB	3817910600	DAEWOO	TEXAS INSTRUMENT

3. COMPRESSOR CAPACITOR

MODEL	STARTING	PART No.	RUNNING	PART No.	MAKER	Note
TGF-49F	330V 125 μ F	-	400V 20 μ F	-	TECUMSEH(FRANCE)	Comp. Assembly
TGF-23F	160V 315 μ F	-	400V 30 μ F	-	TECUMSEH(FRANCE)	Comp. Assembly
TGF-13F	160V 250 μ F	-	-	-	TECUMSEH(FRANCE)	Comp. Assembly
TGF-9F	220V 100 μ F	401RD35050	230V 10 μ F	400EL15130	DAEWOO	DAEWOO

4. CONDENSER FAN MOTOR

MODEL	PART NAME	PART NO.	POLE	INPUT	TYPE	BLADE (NUMBER)	MAKER
TGF-49F	IS-4420DWSQ-1	3963322020	4P	43W	Shaded Pole Induction	AL (5)	SUNGSHIN
TGF-23F	IS-4420DWSG-1	3963320410	4P	47W	Shaded Pole Induction	AL (5)	SUNGSHIN
TGF-13F TGF-9F	IS-3225DWSK-1	3963326010	2P	36W	Shaded Pole Induction	Zytel (6)	SUNGSHIN

5. EVAPORATER FAN MOTOR

MODEL	PART NAME	PART NO.	POLE	INPUT	TYPE	BLADE (NUMBER)	MAKER
TGF-49F	IS-4420DWSN-2A	3963328120	4P	47W	Shaded Pole Induction	AL (5)	SUNGSHIN
TGF-23F	IS-4420DWSN-2A	3963328120	4P	47W	Shaded Pole Induction	AL (5)	SUNGSHIN

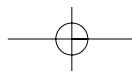

SPECIFICATION OF MAIN COMPONENTS

6. TEMPERATURE CONTROL

MODEL	PART NAME	PART NO.	TYPE	MAKER
TGF-13F	GNF-107DC	30283D0700	NORMAL	SHINHAN
TGF-9F				

7. EVAPORATER DEFROST HEATER

MODEL	PART NAME	PART No.	Spec.	MAKER
TGF-49F	SHEATHED HEATER	30228L0700	600W	SANGDO
TGF-23F	SHEATHED HEATER	30228L0802	445W	SANGDO

8. BALLAST

MODEL	PART NAME MAGNETEK	PART NO.	QTY	WATT	CURRENT	TYPE
TGF-49F	949-LH-TC-P	30200R3102	1	110W	1.7A	Rapid
	B232I120RH-A	30200R4300	1	32W	0.32A	Rapid
TGF-23F	703-L-TC-P	30285R1200	1	17W	0.21A	Rapid
	949-LH-TC-P	30285R1300	1	110W	1.7A	Rapid
TGF-13F	M-132R120C	30200A0120	1	32W	0.32A	Rapid
TGF-9F	727-L-TC-P	30200A0131	1	25W	0.3A	Rapid

9. FLUORESCENT LAMP

MODEL	PART NAME	PART No.	NUMBER	WATT	LENGTH	DESCRIPTION	BULB	MAKER
TGF-49F	F32T8/TL860	30236D0511	1	32W	48"	TL80, 5000K	T8	PHILIPS
	F48T12/CW/1500	30236R1100	1	110W	48"	CW, 4100K	T12	PHILIPS or GE
TGF-23F	F17T8/TL950	30236H0500	1	17W	12"	TL950, 5000K	T8	PHILIPS or GE
	F48T12/CW/VHO	30236R1000	1	110W	48"	CW, 4100K	T12	PHILIPS or GE
TGF-13F	F32T8/TL950	30200D2800	1	32W	48"	TL80, 5000K	T8	PHILIPS
TGF-9F	F25T8/SP41	30236A0500	1	25W	36"	TL80, 5000K	T8	GE

10. ROCKER SWITCH

MODEL	TYPE	PART NO.	RATING	MAKER
TGF-49F	POWER SWITCH (RED)	30281R0200	125V/20A	SIGNAL LUX
TGF-23F	LAMP SWITCH (GREEN)	30281R0100	125V/20A	SIGNAL LUX
TGF-13F	LAMP SWITCH	30281A0600	125V, 6A	DAESUNG
TGF-9F				

11. TRANSFORMER & MAIN PCB

MODEL	TYPE	PART NO.	RATING	NOTE
TGF-49F	TRANSFORMER	30284L0100	115V/60Hz	DWS-115U
	MAIN PCB	30243R0200	115V/60Hz	2GF1151
TGF-23F	TRANSFORMER	30284L0100	115V/60Hz	DWS-115U
	MAIN PCB	30243R0100	115V/60Hz	1GF1151

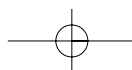

5. ELECTRONIC CONTROLLER INSTRUCTION

Section 5 is for TGF-23F/49F

5-1-1. HOW TO USE THE DISPLAY PANEL(TGF-23F)

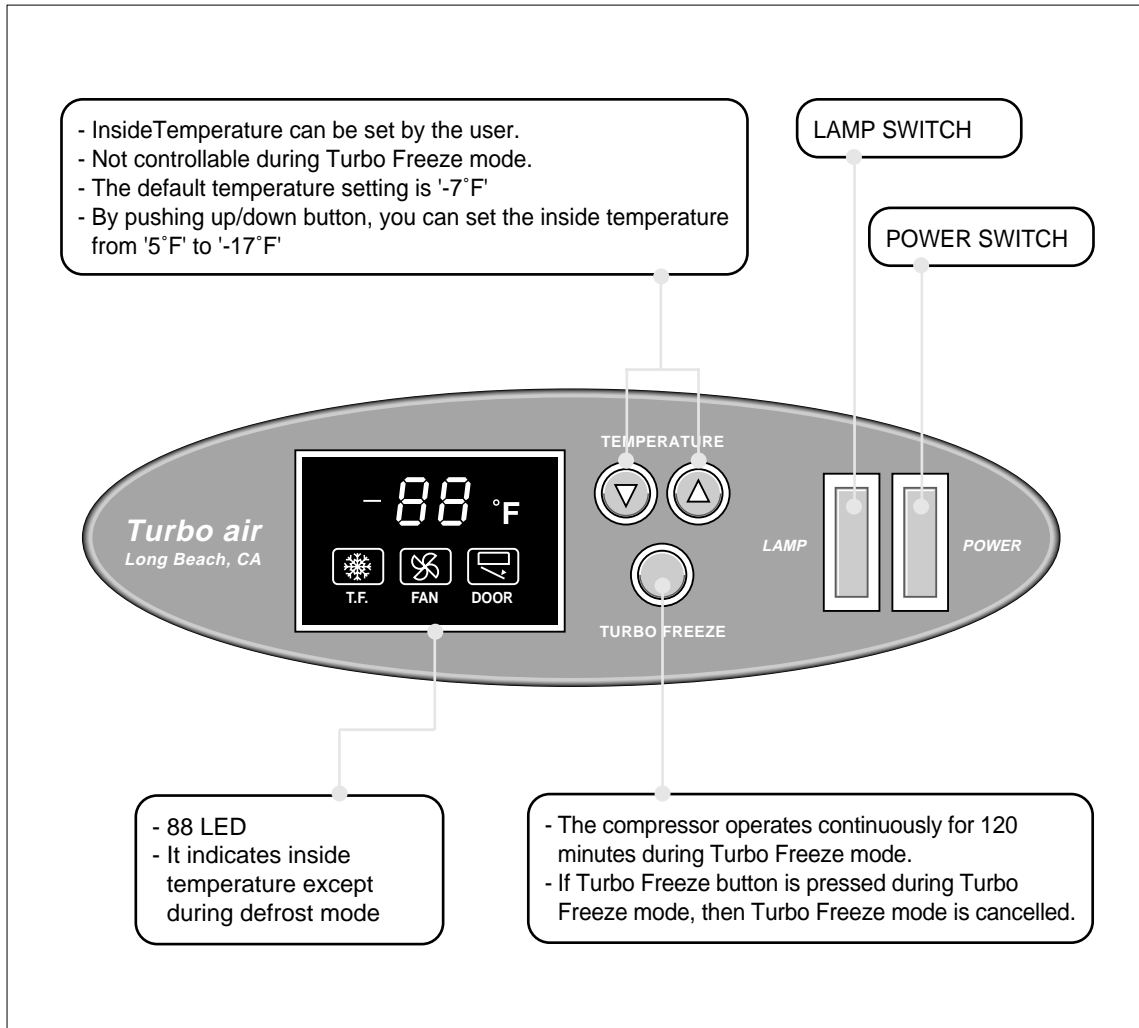

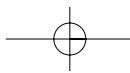

ELECTRONIC CONTROLLER INSTRUCTION

Section 5 is only for TGF-23F/49F

5-1-2. HOW TO USE THE DISPLAY PANEL (TGF-49F)

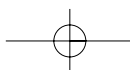
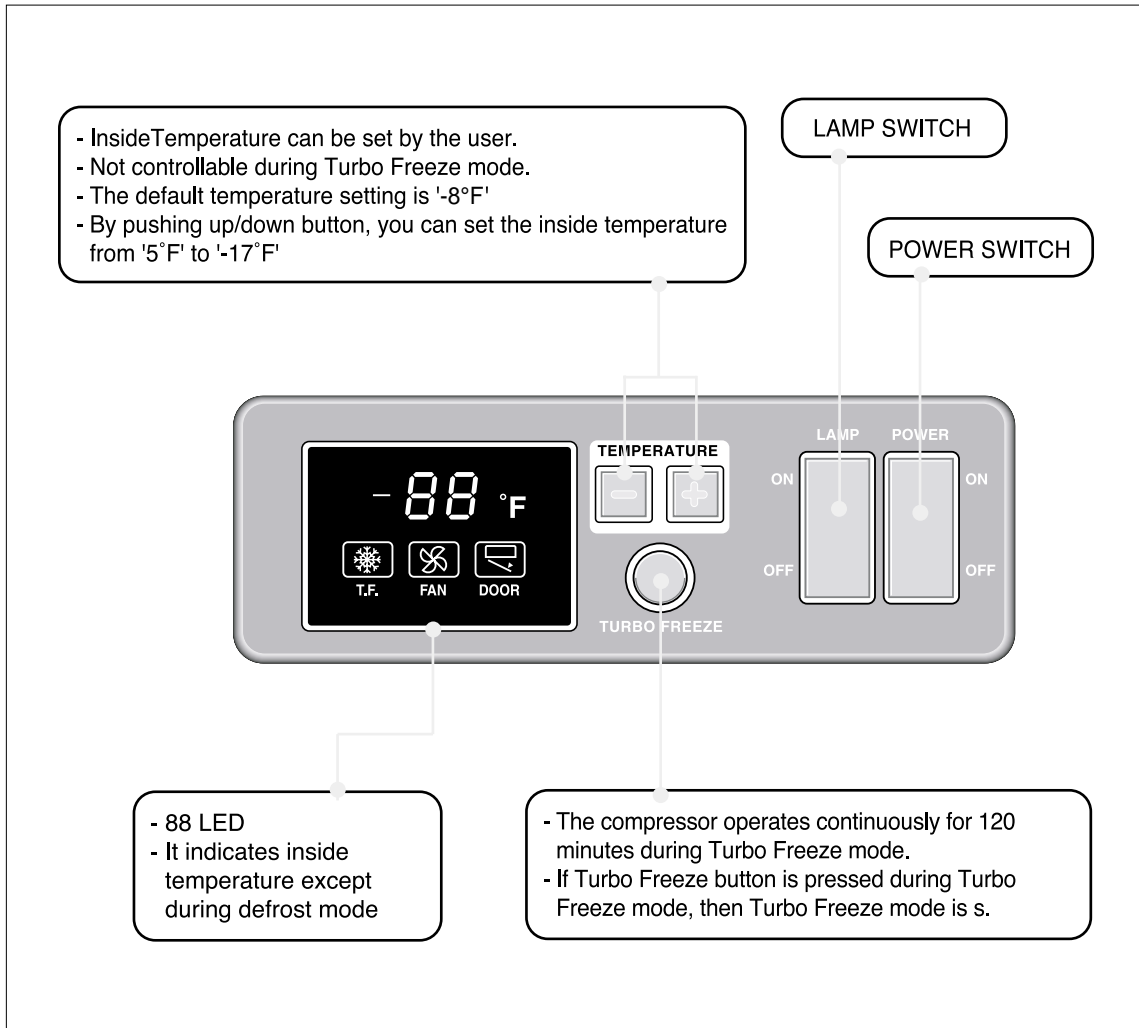



ELECTRONIC CONTROLLER INSTRUCTION

5-2. FUNCTION TABLE

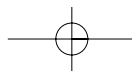
No	Control Function	Control Objects	Contents	Remark																																																																																										
1	Initial Operation	Buzzer Fan Lamp 88 LED	1. Buzzer will be ring within 2 seconds when you plugged-in and turned on the power switch. 2. 88 LED displays inside temperature. 3. Compressor will be run if evaporator's temperature is higher than 38.3°F(3.5°C), compressor will not run for 3 minutes when you plugged-in. 4. The fluorescent lamp will come on, when the inside temperature has reached 23°F(-5°C). 5. If inside temperature is lower than -50°F or higher than 50, 88 LED displays 'Lo' or 'Hi' respectively. 6. Evap. Fan Motor will be run if D-sensor sense lower than 14°F or 10 minutes has passed from when you plugged-in.																																																																																											
2	Temperature Control	Compressor Evap-Fan Motor Con-Fan Motor LED	1. By pushing up/down button, you can set the desired inside temperature from '5°F' to '-17°F'. 2. 88 LED will display a setting temperature, when you push up/down button. 3. 88 LED will indicate real inside temperature, after your setting. 4. Buzzer rings 1 time whenever each button is pressed. 5. Compressor automatically turns on and off by F-sensor (Except error mode) 6. Compressor will not come on for 3 minutes After Compressor is Off, even though the F-sensor is at On point. 7. Evap. Fan Motor runs continuously except when door is opened and during defrost mode. 8. Evap. Fan Motor will start within 3 seconds when door is closed. 9. Compressor On/off temperature(°F) <table border="1" style="width: 100%; border-collapse: collapse; text-align: center;"> <tr> <td>Setting</td> <td>5</td> <td>4</td> <td>3</td> <td>2</td> <td>1</td> </tr> <tr> <td>Comp On</td> <td>9</td> <td>8</td> <td>7</td> <td>6</td> <td>5</td> </tr> <tr> <td>Comp Off</td> <td>1</td> <td>0</td> <td>-1</td> <td>-2</td> <td>-3</td> </tr> <tr> <td>Setting</td> <td>0</td> <td>-1</td> <td>-2</td> <td>-3</td> <td>-4</td> </tr> <tr> <td>Comp On</td> <td>4</td> <td>3</td> <td>2</td> <td>1</td> <td>0</td> </tr> <tr> <td>Comp Off</td> <td>-4</td> <td>-5</td> <td>-6</td> <td>-7</td> <td>-8</td> </tr> <tr> <td>Setting</td> <td>-5</td> <td>-6</td> <td>-7</td> <td>-8</td> <td>-9</td> </tr> <tr> <td>Comp On</td> <td>-1</td> <td>-2</td> <td>-3</td> <td>-4</td> <td>-5</td> </tr> <tr> <td>Comp Off</td> <td>-9</td> <td>-10</td> <td>-11</td> <td>-12</td> <td>-13</td> </tr> <tr> <td>Setting</td> <td>-10</td> <td>-11</td> <td>-12</td> <td>-13</td> <td>-14</td> </tr> <tr> <td>Comp On</td> <td>-6</td> <td>-7</td> <td>-8</td> <td>-9</td> <td>-10</td> </tr> <tr> <td>Comp Off</td> <td>-14</td> <td>-15</td> <td>-16</td> <td>-17</td> <td>-18</td> </tr> <tr> <td>Setting</td> <td>-15</td> <td>-16</td> <td>-17</td> <td></td> <td></td> </tr> <tr> <td>Comp On</td> <td>-11</td> <td>-12</td> <td>-13</td> <td></td> <td></td> </tr> <tr> <td>Comp Off</td> <td>-19</td> <td>-20</td> <td>-21</td> <td></td> <td></td> </tr> </table>	Setting	5	4	3	2	1	Comp On	9	8	7	6	5	Comp Off	1	0	-1	-2	-3	Setting	0	-1	-2	-3	-4	Comp On	4	3	2	1	0	Comp Off	-4	-5	-6	-7	-8	Setting	-5	-6	-7	-8	-9	Comp On	-1	-2	-3	-4	-5	Comp Off	-9	-10	-11	-12	-13	Setting	-10	-11	-12	-13	-14	Comp On	-6	-7	-8	-9	-10	Comp Off	-14	-15	-16	-17	-18	Setting	-15	-16	-17			Comp On	-11	-12	-13			Comp Off	-19	-20	-21			
Setting	5	4	3	2	1																																																																																									
Comp On	9	8	7	6	5																																																																																									
Comp Off	1	0	-1	-2	-3																																																																																									
Setting	0	-1	-2	-3	-4																																																																																									
Comp On	4	3	2	1	0																																																																																									
Comp Off	-4	-5	-6	-7	-8																																																																																									
Setting	-5	-6	-7	-8	-9																																																																																									
Comp On	-1	-2	-3	-4	-5																																																																																									
Comp Off	-9	-10	-11	-12	-13																																																																																									
Setting	-10	-11	-12	-13	-14																																																																																									
Comp On	-6	-7	-8	-9	-10																																																																																									
Comp Off	-14	-15	-16	-17	-18																																																																																									
Setting	-15	-16	-17																																																																																											
Comp On	-11	-12	-13																																																																																											
Comp Off	-19	-20	-21																																																																																											
3	Turbo Freeze	Compressor Evap-Fan Motor Con-Fan Motor LED	1. If the Turbo Freeze button is pressed, the Turbo freeze mode will start. 2. If the Turbo Freeze button is pressed during the Turbo Freeze mode, the Turbo Freeze mode is cancelled. 3. During the Turbo Freeze mode, the temperature up/down button will not by operated. 4. T.F lamp in 88 LED is lighted during the Turbo Freeze mode. 5. The compressor and Condenser-Fan Motor operate continuously for 120 minutes.																																																																																											

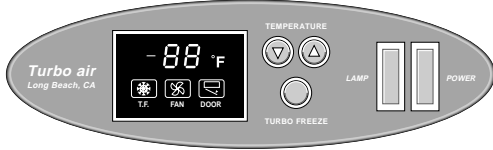

ELECTRONIC CONTROLLER INSTRUCTION

No	Control Function	Control Objects	Contents	Remark																														
3	Turbo Freeze	Compressor Evap-Fan Motor Con-Fan Motor LED	<p>6. If you press the Turbo Freeze button during the defrost mode, display panel displays Turbo Freeze mode but actually The Turbo Freeze mode will start after defrost mode is completed.</p> <p>7. If defrost mode occurs during the Turbo Freeze mode, the defrost mode will start after the Turbo Freeze mode is completed</p> 																															
4	Determination Of Defrost		<p>1. Defrost mode is controlled by a time interval setting.</p> <p>2. The time interval setting can be set by shifting dip s/w on the PCB board.</p> <p>3. The time interval setting is as follows.</p> <table border="1" data-bbox="651 887 986 1025"> <thead> <tr> <th colspan="2">Dip Switch</th> <th rowspan="2">Cycle time(hours)</th> </tr> <tr> <th>NO.1</th> <th>NO.2</th> </tr> </thead> <tbody> <tr> <td>0</td> <td>0</td> <td>12</td> </tr> <tr> <td>1</td> <td>0</td> <td>10</td> </tr> <tr> <td>0</td> <td>1</td> <td>8</td> </tr> <tr> <td>1</td> <td>1</td> <td>6</td> </tr> </tbody> </table>  <p>4. Factory setting is to defrost every 8 hours (see the above picture.)</p> <p>5. The first defrost mode will start at half of time interval setting of when unit was plugged-in.</p>	Dip Switch		Cycle time(hours)	NO.1	NO.2	0	0	12	1	0	10	0	1	8	1	1	6														
Dip Switch		Cycle time(hours)																																
NO.1	NO.2																																	
0	0	12																																
1	0	10																																
0	1	8																																
1	1	6																																
5	Defrost Function	Heater Compressor Evap-Fan Motor Con-Fan Motor	<p>1. Defrost step</p> <table border="1" data-bbox="611 1182 1254 1344"> <thead> <tr> <th></th> <th><i>Pre-cool</i></th> <th><i>Heater</i></th> <th><i>Pause</i></th> <th><i>Fan Delay</i></th> </tr> </thead> <tbody> <tr> <td>Comp.</td> <td><i>on</i></td> <td><i>off</i></td> <td><i>off</i></td> <td><i>on</i></td> </tr> <tr> <td>F-fan motor</td> <td><i>on</i></td> <td><i>off</i></td> <td><i>off</i></td> <td><i>off</i></td> </tr> <tr> <td>C-fan motor</td> <td><i>on</i></td> <td><i>off</i></td> <td><i>off</i></td> <td><i>on</i></td> </tr> <tr> <td>Heater</td> <td><i>off</i></td> <td><i>on</i></td> <td><i>off</i></td> <td><i>off</i></td> </tr> <tr> <td>Max time</td> <td><i>30 min.</i></td> <td><i>40 min.</i></td> <td><i>3 min.</i></td> <td><i>5 min.</i></td> </tr> </tbody> </table> <p><i>If D-sensor temperature is over 50°F, heater goes off.</i></p> <p><i>If D-sensor is in error, heater goes off automatically 40 min after activated.</i></p> <p><i>If D-sensor temp. lower than 14°F, then F-fan turns on immediately</i></p> <p>A. Pre-Cool Step</p> <ol style="list-style-type: none"> It prevents from extreme temperature rise during defrost mode. Comp. Con-Fan Motor and Evap-Fan Motor run continuously during pre-cool step. 88 LED indicates inside temperature. If F-sensor is sensing lower temperature than (-22)°F(-30°C) or pre-cool step interval reach in 30 minutes, pre-cool step goes off. Turbo Freeze mode is only one time prior to pre-cool step. <p>B. Heater defrost step</p> <ol style="list-style-type: none"> The defrost heater is energized. 88 LED displays 'dF' The defrost heater warms the evaporator coil thereby melting all frost that accumulated during the previous refrigeration cycle. When D-sensor is higher than 47°F(8°C...), heater goes off. 		<i>Pre-cool</i>	<i>Heater</i>	<i>Pause</i>	<i>Fan Delay</i>	Comp.	<i>on</i>	<i>off</i>	<i>off</i>	<i>on</i>	F-fan motor	<i>on</i>	<i>off</i>	<i>off</i>	<i>off</i>	C-fan motor	<i>on</i>	<i>off</i>	<i>off</i>	<i>on</i>	Heater	<i>off</i>	<i>on</i>	<i>off</i>	<i>off</i>	Max time	<i>30 min.</i>	<i>40 min.</i>	<i>3 min.</i>	<i>5 min.</i>	
	<i>Pre-cool</i>	<i>Heater</i>	<i>Pause</i>	<i>Fan Delay</i>																														
Comp.	<i>on</i>	<i>off</i>	<i>off</i>	<i>on</i>																														
F-fan motor	<i>on</i>	<i>off</i>	<i>off</i>	<i>off</i>																														
C-fan motor	<i>on</i>	<i>off</i>	<i>off</i>	<i>on</i>																														
Heater	<i>off</i>	<i>on</i>	<i>off</i>	<i>off</i>																														
Max time	<i>30 min.</i>	<i>40 min.</i>	<i>3 min.</i>	<i>5 min.</i>																														

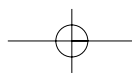

ELECTRONIC CONTROLLER INSTRUCTION

No	Control Function	Control Objects	Contents	Remark
5	Defrost Function	Heater Compressor Evap-Fan Motor Con-Fan Motor	<p>f. If Defrost Heater's on time exceeds 40 minutes for any reason, a back-up defrost termination switch is also provided.</p> <p>g. If D-sensor's temperature does not reach 47°F(8°C) in 40 minutes, error code will be recorded on a MICOM.</p>  <p>C. Pause step a. Time = 3 min. b. 88 LED displays 'dF'</p> <p>D. Fan delay step a. Max. Time = 5 min b. Only Comp. is On. c. If D-sensor temperature goes down under 14°F in 5 minutes, Evap.-Fan Motor turns on immediately.</p>	
6	Manual Defrost	Compressor Evap-Fan Motor Con-Fan Motor Heater	<ol style="list-style-type: none"> Press the Turbo Freeze button 5 seconds, While pressing both up/down button at the same time. Manual defrost mode. <ol style="list-style-type: none"> The pre-cool step is omitted. It starts from heater defrost step. The next procedure is the same as that of the defrost mode. 	
7	Comp Restart Prevent	Compressor Con-Fan Motor	<ol style="list-style-type: none"> Compressor will not start for 3 minutes after compressor is off, even though the F-sensor is at on point. 	
8	Power Failure Back-Up Function	Compressor Evap-Fan Motor Con-Fan Motor	<ol style="list-style-type: none"> Compressor will not start for 3 minutes after power failure. Evap.-Fan Motor is on. 	
9	Door opening Alarm function	Buzzer LED	<ol style="list-style-type: none"> If door is opened, light on display board for fan turns off and door open indicating lamp turns on. If door is opened more than 30 seconds, display will beep 3 times. If door is opened more than 60 seconds, display will beep 5 times. If door is opened more than 5 minutes, display will beep continuously. 	
10	Buzzer Function	Buzzer	<ol style="list-style-type: none"> Beep sound rings 1 time after initial power on. Beep sound rings whenever each button is pressed. Beep sound rings if door is opened a certain time period. (See door opening alarm function) 	
11	Error Display	LED	<ol style="list-style-type: none"> Press up button 5 times while pressing both down button and Turbo Freeze button at same. Above procedure switches normal display to error display mode. If there was no error occurred, there will be no change on the 88 LED. If there was error occurred, 88 LED will display the error code. Next error code will be displayed by pressing down button. 10 seconds after the last button pressed, error display mode will be switched to normal display mode. 	

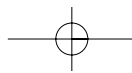

ELECTRONIC CONTROLLER INSTRUCTION

No	Control Function	Control Objects	Contents	Remark
12	Fuzzy Deforst	Heater Compressor Evap-Fan Motor Con-Fan Motor	The Defrost step will be started at following conditions. 1. The compressor has run for 30 minutes. 2. There is no opening the door for 30 minutes. 3. The temperature of D-sensor is lower than 5°F. 4. The temperature of F-sensor is higher than D-sensor's temperature by 53.6°F for 10 minutes.	

5-3. Self - Diagnosis table

Code	Content	Perception Method	Freezer operation state
F1	F-sensor Malfunction	- Sensor shorted - Sensor disconnected	- The compressor runs for 30 minutes and rests for 5 minutes. - Above action will repeat, until it is repaired.
D1	D-sensor Malfunction	- Sensor shorted - Sensor disconnected	- Defrost heater will attempt to defrost. - If F-sensor temp. is higher than 28.4°F then heater goes off. - Heater turns on for 20 minutes, if F-sensor is in error mode too.
C1	Cycle, Comp. Malfunction	- When the temperature of the D-sensor is over 32°F although the compressor has been running for 30 minutes.	- Normal operation. (Compressor is automatically turned on and off by F-sensor.)
F3	Defrost Malfunction	When the D-sensor temperature doesn't reach 47°F within 40 minutes.	- Defrost heater will be come on for 40 minutes every time settled. - If the D-sensor's temp. reach 47°F within 40 minutes, D-heater will be turned off immediately.

5-4. Sensor Description

Sensor	Operation	Description	Remarks
F-sensor	-Thermistor(Electrical resistance varies with temperature changing) -Act like thermostat. Detects air temperature.	- Wire color is orange.	
D-sensor	-Thermistor(Electrical resistance varies with temperature changing) -Act like thermostat. Detects Evap. coil's temperature.	- Wire color is blue.	

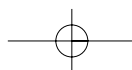

6. PARTS LIST

Part Name	Part Number	Description	Model			
			49F	23F	13F	9F
Casters						
Caster	30265L0400	TP5040-22-HDP	2	2		
Caster with Brake	30265L0300	TP5040-22-HDP-TLB	2	2		
Caster	30265H0100	1/2" Stem (TP3625-21-HR)			2	2
Caster	30265H0200	1/2" Stem (TP3625-21-HR-TLB)			2	2
Compressor						
Compressor	30200R1900	CAJ2464Z(FRANCE TECUMSEH)	1			
Compressor	30200R0100	CAJ2432Z(FRANCE TECUMSEH)		1		
Compressor	30200N4400	AEZ2415Z(TECUMSEH FRANCE)			1	
Compressor	3952127G30	HBL27YE-1(DAEWOO)				1
PowerRelay(Comp.Relay)	30281H0330	UZ2ABT 110(YUYU)	1	1		
Main Power Cord	30213Q0201	125V,220V /20A	1			
Main Power Cord	30213A1010	125V/15A		1		
Compressor Relay	3817906900	PTC 068				1
Compressor Relay Assembly	30200N4501	Including Harnes				1
Compressor Overload	3817908600	4TM-783RHB (TEXASINS.)				1
Compressor Run Capacitor	400EL15130	230V 10uF				1
Compressor Start Capacitor	401RD35050	220V 100uF				1
Compressor Capacitor Fixture	3022006000	SPG				1
Condenser						
Condenser Coil	30200R3300	TGF-49F	1			
Condenser Coil	30200R0200	TGF-23F		1		
Condenser Coil	30200N5300	Refer Parts Diagram			1	
Condenser Coil	30200N5201	Refer Parts Diagram				1
Condenser Fan Motor	3963322020	IS-4420DWSQ1	2			
Condenser Fan Motor	3963220410	IS-4420DWSG1		1		
Condenser Fan Motor	3963326010	IS-3225DWSK1			1	1
Condenser Fan Moter Blade	30218B0100	AL, ø225, No of BLADE: 4	2			
Condenser Fan Moter Blade	30218F0100	Zytel, ø150, No of BLADE: 6			1	1
Condenser Fan Moter Blade	30218A0300	AL, ø250, No of BLADE: 5		1		
Compressor Dryer	30268Q0300	C-052-S	1	1		
Compressor Dryer	30268N0100	15g, Refer Parts Diagram			1	
Compressor Dryer	3016800103	10g, Refer Parts Diagram				1
Rear Grill	30214R7600	SWRM-B	1			
Rear Grill	30214Q5000	SWRM-B		1		
Capillary Tube	30244R2500	L4425xø2.0(ID)	1			
Capillary Tube	30244R2000	L2700xø1.6(ID)		1		
Power Cord	30213A1000	KKP-30B		1	1	1
Power Cord Clamp	30212A0600	SPG		1	1	1
Condenser Coil Shroud	30214N2003	SWRM-B			1	
Condenser Coil Shroud	30214N1903	SWRM-B				1

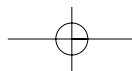

PARTS LIST

Part Name	Part Number	Description	Model			
			49F	23F	13F	9F
Evaporator						
Evaporator Coil	30270R0200	TGF-49F	1			
Evaporator Coil	30270R0100	TGF-23F		1		
Evaporator Sensor (D-senser+F-Senser)	30227Q1200	TH225J37/TH310H34	1			
Evaporator Sensor (D-senser+F-Senser)	30227L1101	TH225J/TH310H		1		
Evaporator Thermal Fuse	30272L0400	PST-3(80/10)		1		
Evaporator Drain Pan Heater	30228L1500	90W	1			
Evaporator Drain Pan Heater	30228L1400	90W		1		
Evaporator Defrost Heater	30228L0700	600W	1			
Evaporator Defrost Heater	30228L0802	445W		1		
Drain Hose Heater	30228L1310	10W, L=700mm	1			
Drain Hose Heater	30228L1300	10W, L=700mm		1		
Drain Pan Insulator	30233L0200	E-PS	1			
Drain Pan Insulator	30233L0100	E-PS	2	1		
Evaporator Fan Motor Guard	30214K0100	ABS	2	1		
Evaporator Fan Motor Blade	30218F0200	AL,ø175	2	1		
Evaporator Fan Motor	3963328120	IS-4420DWSN-2A	2	1		
Duct(A)	30269R0400	SPG, WH	1			
Duct(B)	30269R0300	SPG, WH	1			
Duct(A)	30269R0100	EGL, Painting		1		
Duct(B)	30269R0200	EGL, Painting		1		
Evaporator URT Foam Assembly	30270H0100	TGF-13F			1	
Evaporator URT Foam Assembly	4034L05103	TGF-9F				1
Evaporator*Top	3020000702	ROLLBOND(AL)			1	
Evaporator*Top	3020000305	ROLLBOND(AL)				1
Insulation Cover	30214N0800	PVC-H			1	
Insulation Cover	30214N0700	PVC-H				1
Insulation Cover Heater	30228N0800	4W, L:1420			1	
Insulation Cover Heater	30228N0700	4W, L:994				1
Door						
Door Assembly(Left)	30200R3600	Heated Glass, Swing	1			
Door Assembly(Right)	30200R3500	Heated Glass, Swing	1			
Door Assembly	30200R1500	Heated Glass, Swing		1		
Door Assembly	30200N4600	Glass, Slide			2	
Door Assembly	30200N4300	Glass, Slide				1
Door Glass	30255N0300	T4,684x323			1	
Front Glass	3025500100	T12,1492x110			1	
Door Glass	30255N0100	T4,1001x323				1
Front Glass	30255N0200	T4,1067x110				1
Door Glass	30255R0100	HeatedGlass		1		
Door Gasket	30223R0100	PVC-S,1350x650		1		
Lamp Socket(A)	30230R1100	without spring	1	1		
Lamp Socket(B)	30230R1000	with spring	1	1		
Lamp Shield Cap	30214R0100	ABS		1		
Lamp Shield	30242R1100	PC		1		

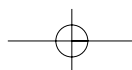

PARTS LIST

Part Name	Part Number	Description	Model			
			49F	23F	13F	9F
Lamp Socket Bracket	30206R1000	SPG, Painting		1		
Lamp Shield Fixture	30220R1100	EGI, Painting		1		
Door Handle	30226A0101	Slide, ABS Plastic, Gray			1	1
Door Rail (Middle)	30287N0201	PVC-H			1	
SignPanel						
Ballast	30200R4300	B232I120RH-A	1			
Ballast	30285R1200	17Wattx1, R-1P17-TP		1		
Ballast	30200A0120	32Wattx1, R-1P32-TP			1	
Ballast	30200A0131	25Wattx1, R-1P825-TP				1
Lamp	30236R1100	F48T12/CW/1500	1			
Lamp	30236D0511	F32T8 TL860	1			
Lamp	30236H0500	17Watt, F17T8/TL950, 12"		1		
Lamp	30200D2800	32Watt, F32T8/TL850, 48"			1	
Lamp	30236A0500	25Watt, F25T8/TL950, 36"				1
Sign Panel	30214N170P	HIPS			1	
Sign Panel	302141020P	HIPS				1
Lamp Holder	3183005000	SK-10, OD28			1	1
Lamp Switch	30281A0600	125V, 6A			1	1
Lamp Socket	30279N0100	Including Harness			1	
Lamp Socket	3027900113	Including Harness				1
Decoration Cover (Left)	30214N0100	ABS Plastic, Gray			1	1
Decoration Cover (Right)	30214N0200	ABS Plastic, Gray			1	1
Sign Panel	30242R1000	PC		1		
Lamp Holder	3183005000	JS 103	2	1		
Door Switch	30281R0100	E3101CA	2	1		
Lamp Socket	30227R2400	Including Harness	1			
Lamp Socket	30227R1000	Including Harness		1		
Sign Frame*Top	30222R0200	AL,Painting		1		
Sign Frame*Bottom	30222R0100	AL,Painting		1		
Sign Frame*Right	30222A2500	ABS		1		
Sign Frame*Left	30222R2400	ABS		1		
Sign Panel	30274R0100	HIPS	1			
Sign Frame*Top	30222R2001	AL White COATING	1			
Sign Frame*Bottom	30222R2101	AL White COATING	1			
Sign Frame*Right	30222R2300	ABS White	1			
Sign Frame*Left	30220R2200	ABS White	1			
BottomGrill						
Bottom Grill	30224R0100	ABS		1		
Bottom Grill	30200R3400	Coated steel	1			
Display Panel Cover	30217R0100	PC		1		
Main PCB	30243R0100	1GF1151		1		
Main PCB	30243R0200	2GF1151	1			
DisplayPCB	30242R0100	TGF-23F		1		
Power Switch	30281R0200	ROCKER TYPE, RED		1		
Lamp Switch	30281R0300	ROCKER TYPE, GREEN		1		

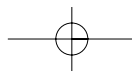

PARTS LIST

Part Name	Part Number	Description	Model			
			49F	23F	13F	9F
Transformer	30284L0100	DWS-115U	1	1		
Ballast	30200R3102	949-LH-TC-P(MAGNETEK)	1	1		
Shelf						
ShelfStandard	30220L1001	SUS304-2B		4		
Shelf *L	30250R0600	SWRM-B	4			
Shelf *R	30250R0500	SWRM-B	4			
Shelf	30278R0100	Wire, White		4		
ShelfClip	30220L0900	PA-6		16		
BackGuard (AirBaffleBack)	30250R0200	Wire, White		2		
Thermostat						
Themperture Control	30283N0100	GNF-107DC(SHINHAN)			1	1

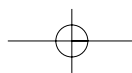

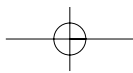

7. REPLACEMENT OF MAIN COMPONENTS

7-1. BOTTOM GRILLE PARTS(TGF-23F)

- MAIN PCB, TRANSFORMER, POWER RELAY
- DISPLAY P.C.B.
- LAMP SWITCH, POWER SWITCH

A. Remove Bottom Grille by unscrewing the four screws.



B. Remove the Bracket of Display P.C.B.

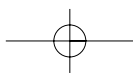
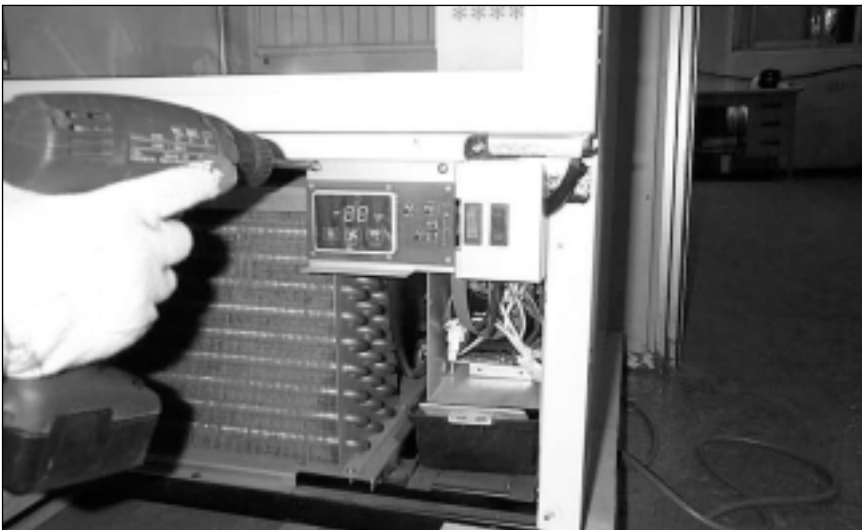

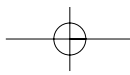

REPLACEMENT OF MAIN COMPONENTS

C. Disconnect Connectors and receptacles.

- Replace the Power Switch, Lamp Switch or Display P.C.B.



D. Remove the electrical box (Switch Box) cover.

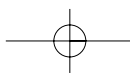

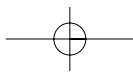

REPLACEMENT OF MAIN COMPONENTS

E. Remove the Fixture.

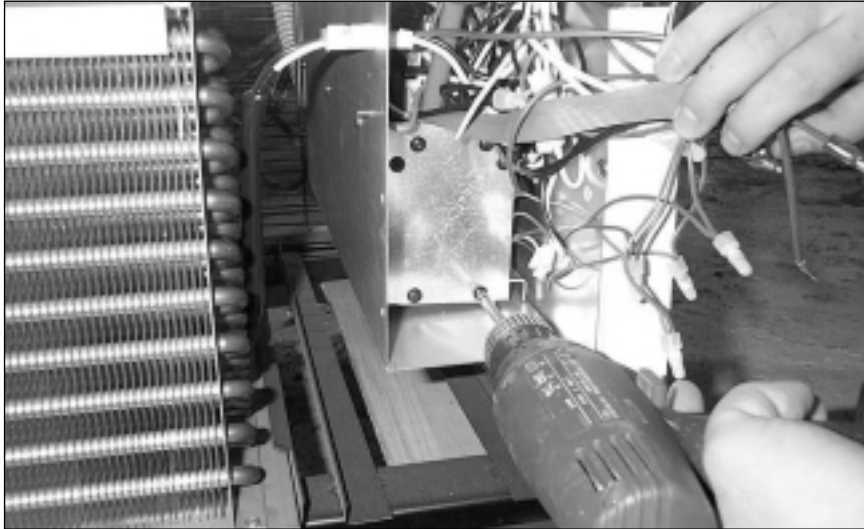

F. Replace the Ballast. (for inner Cabinet Lamp. 110W)

1. Pull out the Ballast Base.
2. Replace the Ballast.

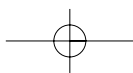
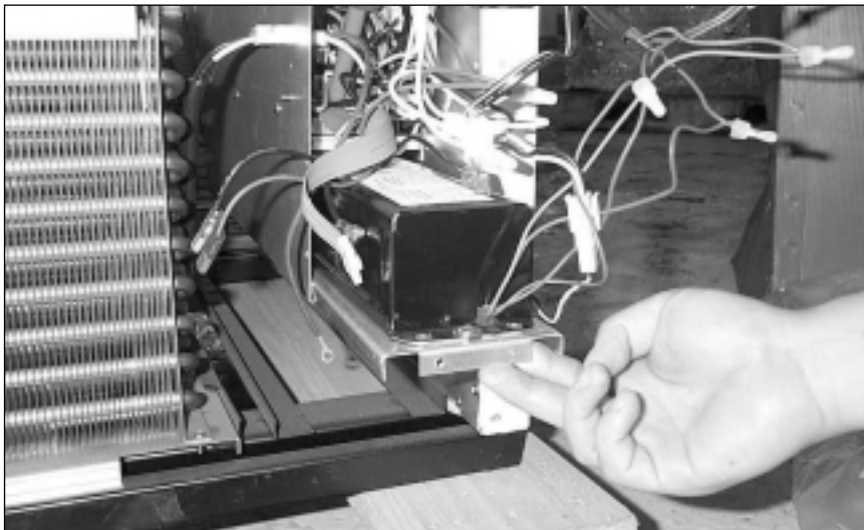

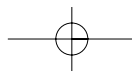

REPLACEMENT OF MAIN COMPONENTS

G. Replace the Main P.C.B. Transformer and Power Relay.

1. Pull out the Base.
2. Replace the parts.

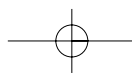
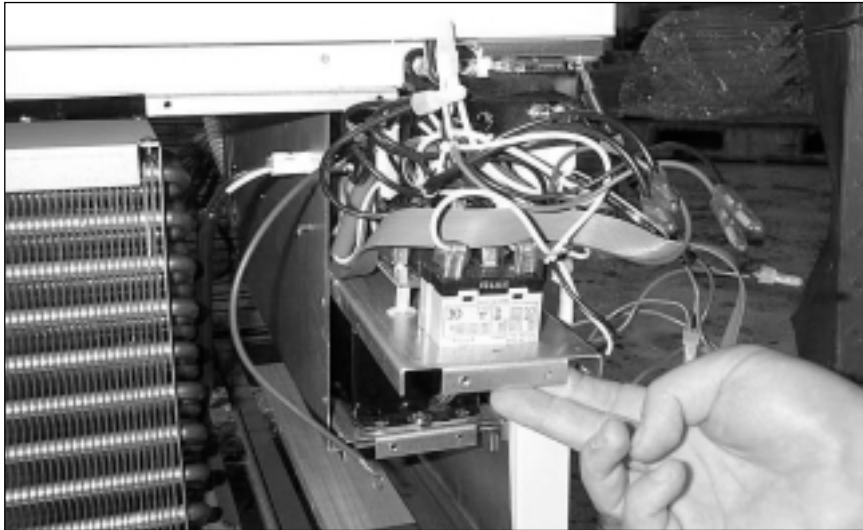

REPLACEMENT OF MAIN COMPONENTS

7-2. REPLACING DOOR (TGF-23F)

- A. Disassemble bottom grille as described section 7-1, A, B, C, D.
- B. Disconnect the door heater wire and lamp wire.

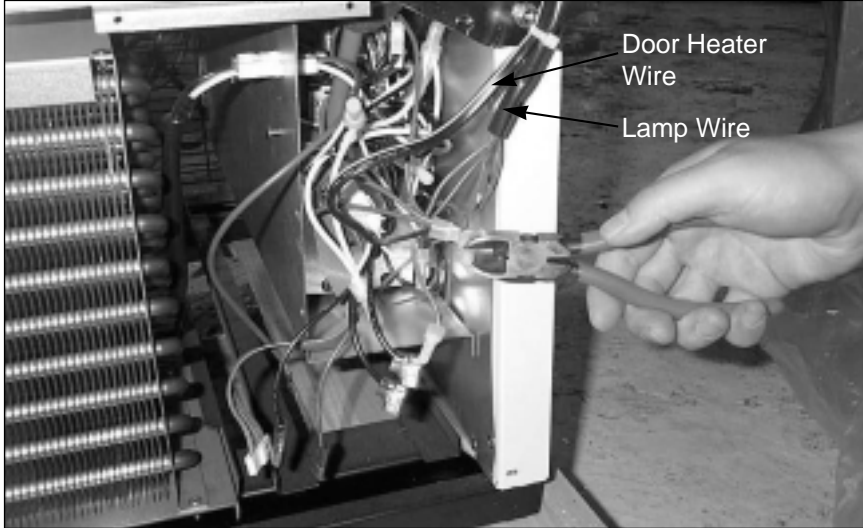

- C. Remove the Sign Frame (Left, Right) by unscrewing the four screws of each side.



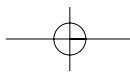

REPLACEMENT OF MAIN COMPONENTS

D. Pull out sign panel to the Right Side.



F. Remove the sign panel frame *Bottom.
- Replace the Ballast (Sign Panel)

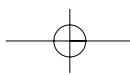

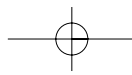

REPLACEMENT OF MAIN COMPONENTS

E. Remove the harness of door switch.

- Replace door Switch.



G. Remove the door hinge top.

H. Lift the door and pull out the door wires.

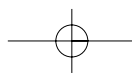

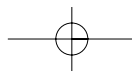

REPLACEMENT OF MAIN COMPONENTS

7-1. TOP ADVERTISING PANEL (TGF-49F)

- MAIN PCB, TRANSFORMER
- LAMP SWITCH, POWER SWITCH
- DISPLAY P.C.B

A. Remove the Sign Frame by unscrewing two screws of left side.



B. Pull out the sign panel from left side.

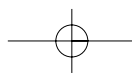

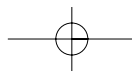

REPLACEMENT OF MAIN COMPONENTS

C. Replace the TRANSFORMER.



D. Grip the fixture with long nose and pull out the Main P.C.B. - Replace the Main P.C.B.

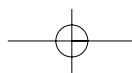
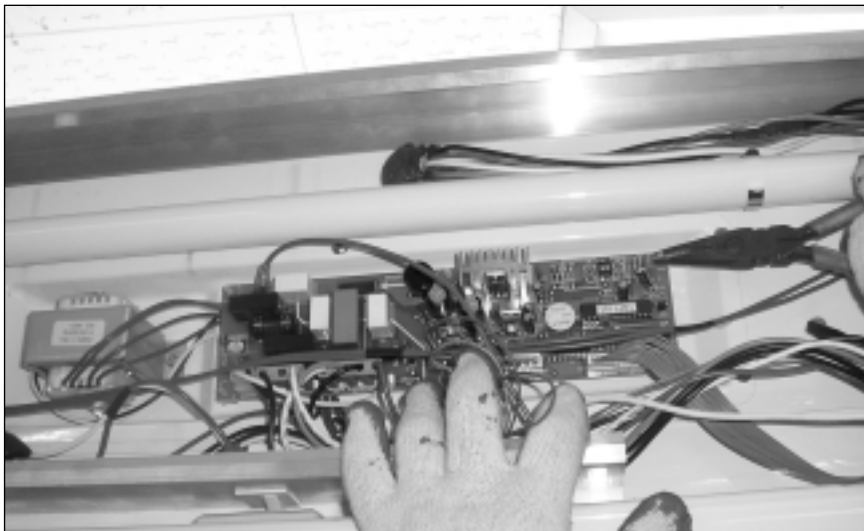

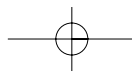

REPLACEMENT OF MAIN COMPONENTS

E. Disconnect Connectors and receptacles.

- Replace the Lamp switch and the Power switch
- Unscrew four screws and replace the Display PCB

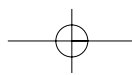

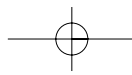

REPLACEMENT OF MAIN COMPONENTS

7-2. BOTTOM GRILLE PARTS (TGF-49F)

- POWER RELAY
- BALLAST(For Inner Cabinet Lamp)

A. Remove the Bottom Grill by unscrewing four screws.



B. Unscrew the cover plate each side.

- Remove the junction cover

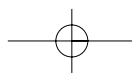
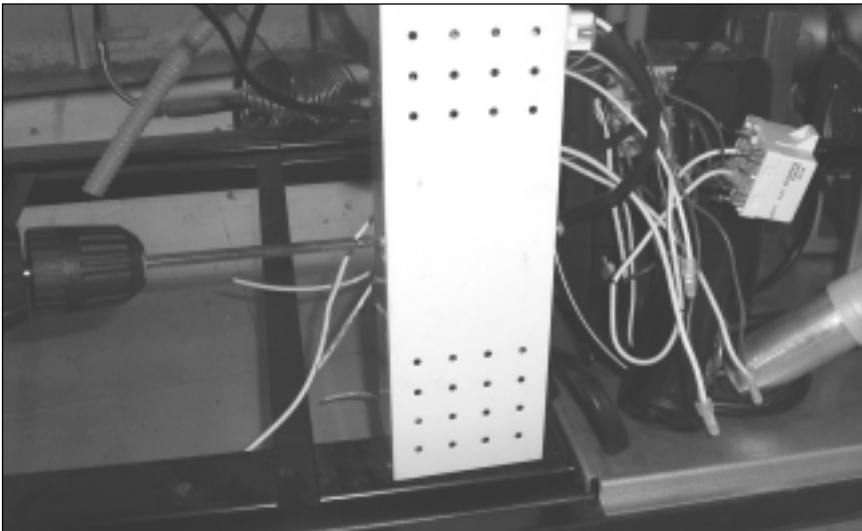

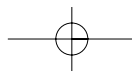

REPLACEMENT OF MAIN COMPONENTS

C. Disconnect receptacles and unscrew two screws.

- Replace the Power relay



D. Remove the Drain case.

- Pull out the Drain case.

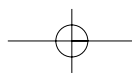
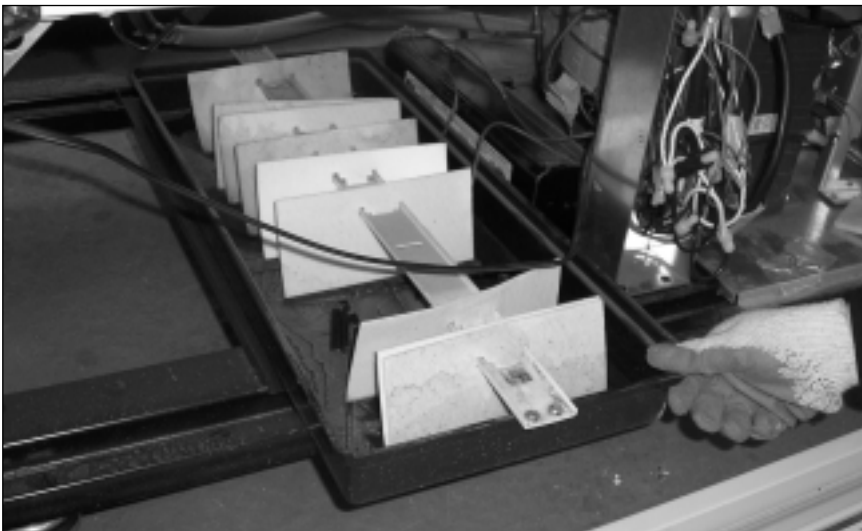

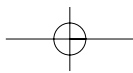

REPLACEMENT OF MAIN COMPONENTS

- E. Unscrew two screws on the Ballast bracket. (for Inner Cabinet Lamp. 110W)**
- Replace the Ballast

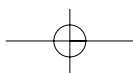
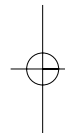
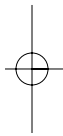

REPLACEMENT OF MAIN COMPONENTS

7-3. REPLACEING DOOR (TGF-49F)

- A. Disassemble bottom grill as described section 7-2, A.
- B. Disconnect Left(right) Door heater wires.

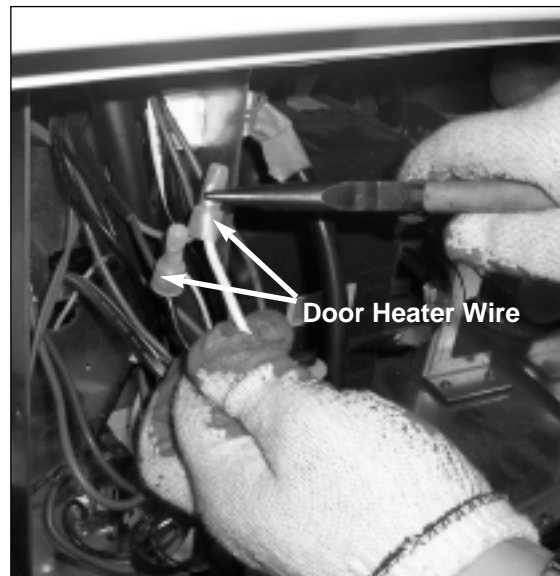
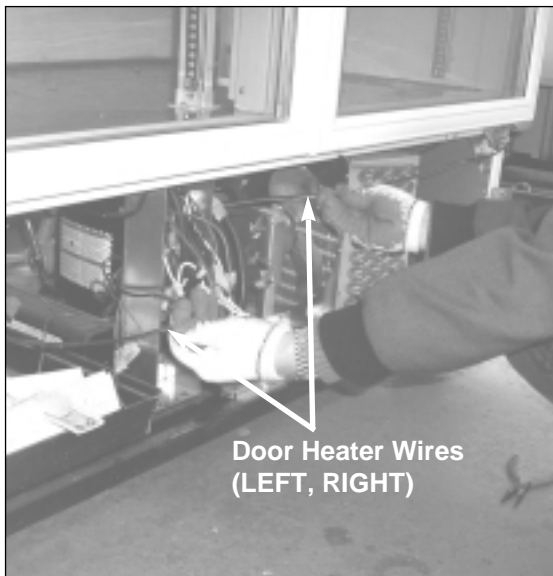

- C. Disconnect Left (Right) Door switch wires.

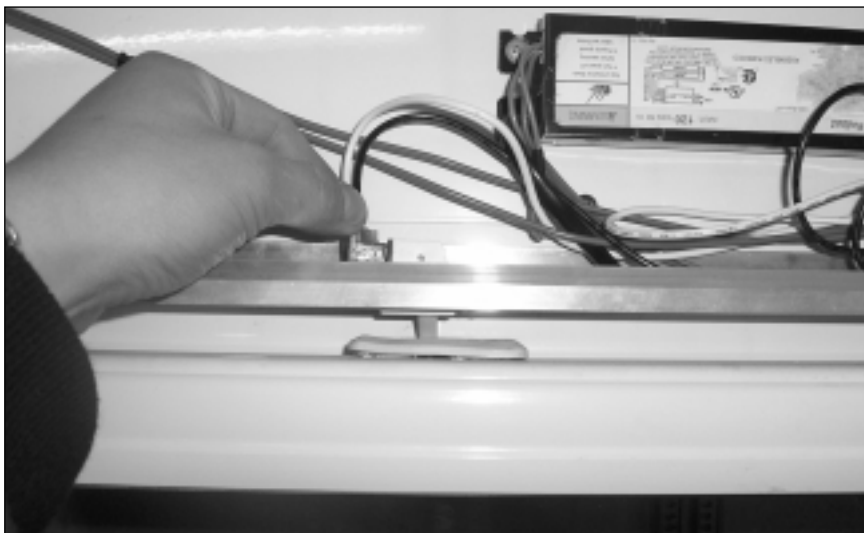

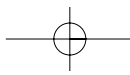

REPLACEMENT OF MAIN COMPONENTS

D. Unscrew the Sign Frame. (Bottom)

- Remove Sign Frame (Bottom)



E. Remove the door hinge(top).

- Lift the door and pull out the door wire.

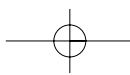

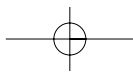

REPLACEMENT OF MAIN COMPONENTS

7-4. REPLACING Inner Cabinet Lamp (TGF-49F)

A. Unscrew the top shelf bracket and Pull out it.



B. Unscrew a bottom screw and separate the shelf bracket.

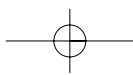

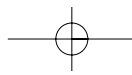

REPLACEMENT OF MAIN COMPONENTS

C. Unscrew the lamp top cover and separate lamp cover.



D. Lift the fluorescent lamp and pull out it.
-Replace the fluorescent light

